

Ventris Dual Reverb User Guide



Welcome

Thank you for purchasing the Ventris Dual Reverb. This powerful stereo reverb pedal features over 12 meticulously crafted reverb engines, dual signal processors, full MIDI functionality, stereo inputs and outputs, external expression capabilities, and advanced effects editing and signal routing options via the Neuro Desktop and Mobile App Editors. The pedal features an exceptional collection of rich, spacious tones, including realistic analog reverbs like Spring and Plate, natural replications of large and small acoustic spaces, and an intriguing and highly musical selection of “unnatural” tones including Reverse, Swell and Shimmer.

The Ventris contains two completely independent reverb processors, essentially housing a matching pair of high-powered reverb pedals in a single box. Its dual reverb platform gives the pedal massive processing power as well as some additional features like unlimited Preset Spillover and the ability to combine two reverb effects with either parallel, cascading or independent channel signal routing.

The Quick Start guide will help you with the basics. For more in-depth information about the Ventris Reverb, move on to the following sections starting with Connections. Enjoy!

- The Source Audio Team

Contents

Welcome.....	1
Overview.....	3
Quick Start	5
Connections	7
Reverb Engines	10
Extended Reverb Engines	18
Controls	20
Preset Storage and Recall.....	26
Universal Bypass.....	30
Stereo Operation & Signal Routing	30
External Control.....	43
Neuro Desktop and Mobile Editors	50
The Neuro Desktop Editor	50
The Neuro Mobile App	60
Neuro Hub	60
MIDI	61
USB.....	62
Specifications.....	62
Troubleshooting	63
Frequently Asked Questions.....	64
Rubber Feet	65
Waste Disposal Notes.....	65
Warranty.....	65
Version History	67

Overview

Over 20 Diverse Reverb Engines – Choose from vintage Spring, Plate, and Hall sounds, natural Room sounds, and unnatural Shimmer, Reverse, and Swell reverbs. 12 factory reverb engines are available out of the box with additional engines available via the Neuro Mobile App or Desktop Editor.

Flexible Stereo Routing – Ventriss is equally at home in a mono or stereo rig. Every reverb effect engine works in True Stereo (stereo in > stereo out), Mono-to-Mono, Mono-to-Stereo, Mono-to-Mono plus dry signal to Output 2, and more. It is also possible to create an external effects loop.

Dual Reverb Processing – Features two completely independent reverb processors – essentially providing two high-powered reverb pedals in a single enclosure. Its dual reverb platform gives the pedal massive processing power as well as some highly advanced features like unlimited Preset Spillover and the ability to combine two reverb effects in either series or parallel.

Preset Spillover - Two individual signal processors make it possible to change from one preset to another without abruptly cutting off the reverb trail of the original preset. Seamless and unlimited “spillover” is an enormous advantage in live situations and there are no limitations to the duration of the transition. Note: Spillover is unavailable when changing between two dual reverb presets (A+B on the toggle switch).

Dual Reverb Presets (In Series or Parallel) - Select the A + B toggle switch position and create dual reverb effects, allowing you to simultaneously engage two different reverb effects with a parallel, cascaded, or left/right signal path.

Analog Dry Through – While engaged the incoming dry signal bypasses the effects processors entirely (for most engines), thereby maintaining a 100% pure dry signal without D/A conversions.

Universal Bypass – Select between true bypass, buffered bypass, or soft bypass with reverb trails. The Ventriss features high-quality signal relays for true bypass and transparent buffers for analog bypass.

Compact Design – The extruded anodized aluminum housing, with its slim profile and small footprint, is built for the rigors of the road.

Presets – Save your favorite sounds with the touch of a button. Save up to 8 presets recallable with the pedal’s onboard controls, plus a total of 128 presets recallable with an external MIDI controller.

Deep Control Set – Beyond the six control knobs on the face of the Ventriss are many additional, editable parameters. The Neuro Mobile App and Neuro Desktop Editor provide access to a vast collection of additional parameters for advanced users who want to create highly customized reverb effects.

Neuro Mobile App – The Neuro App is a free download for iOS and Android mobile devices. The App offers a powerful extension to the basic pedal functionality with a full set of deep editing parameters

and additional reverb engines. Edit your presets and upload them directly to your pedal, save them in your private library of presets, or share them with the entire Neuro Community.

The Neuro Desktop Editor - Connect your Ventris Reverb to the USB port on your Mac or Windows PC to create and save advanced presets with the Neuro Desktop's sleek editing interface. The Neuro software is a free download for Mac or Windows based PCs. Two-way communication between the pedal and your computer also allows the Desktop Editor to see the parameter settings of every preset stored in your Ventris.

Interchangeable Effect Selector Engines – By default the Effect Selector knob features twelve onboard reverb engines, but our Neuro Mobile App and Desktop Editor provide a far deeper set of reverb engines and adjustable parameters for creating highly customized reverb effects. From the Neuro Editor, it is easy to “burn” customized reverb engines directly to any position on the Effect Selector knob.

Neuro Hub – The Source Audio Neuro Hub connects up to five compatible Source Audio pedals and stores the settings of multi-pedal “Scenes.” Up to 128 Scenes can be saved and recalled using the Neuro Hub, combining the power of a multi-effects system with the ease and flexibility of a traditional pedal board.

External Loop – Configure external loop mode to insert external effects within the Ventris's signal chain.

Full MIDI Implementation – The Ventris's parameters can be accessed and controlled using MIDI messages via its 5-pin DIN Input, a Neuro Hub connection, or USB port. Use MIDI messages to engage/disengage the pedal, change presets, move parameters with a MIDI expression controller, and more. Class compliant USB-MIDI allows the Ventris to work as a plug-and-play device with recording software running on Mac and Windows.

Assignable Footswitch – Use the Ventris' second footswitch to control a variety of functions including Tap Tempo, Reverb Hold, and Preset Scrolling.

External Control – Easily configured the Ventris to work with a variety of expression pedals and footswitches for various external control options.

Quick Start

Power

To power the unit, connect the included 9V DC power supply to the jack labeled **DC 9V** on the back panel.

Warning: Using a non-Source Audio supply, especially an unregulated supply, could damage the unit. A power supply with insufficient current levels may also cause noise or other unpredictable behavior. Please be very cautious when using 3rd-party power supplies and refer to the power supply requirements printed on the bottom of the Ventris housing.

Guitar/Audio Connections

Using standard ¼" mono cables, connect your guitar, bass, or other instrument to the INPUT 1 jack and your amp (or the next audio device in the signal chain) to the OUTPUT 1 jack. If you have a second amp, connect it to OUTPUT 2.

When the power and audio connections have been made, the Ventris is ready for use.



Brief Knob, Footswitch, and Button Descriptions

TIME: Controls the duration of the reverb. Turn the TIME knob counter-clockwise to shorten the circulation time of the reverb and clockwise to lengthen it. Setting the TIME knob fully clockwise will cause the reverb to circulate indefinitely.

PRE-DELAY: Adjusts the amount of time between the dry signal and the beginning of the reverb. Turn the PRE-DELAY knob clockwise to create echo reflections similar to slapback or delay effects.

MIX: Controls the relative level between the dry input signal and the wet. When set at 3 o'clock, the wet and dry signals will be at equal volume. Fully counter-clockwise is 100% dry, and fully clockwise is 100% wet.

TREBLE: Controls the cut-off point of a low pass filter on the wet signal. Turn the knob clockwise for brighter reverb trails and counter-clockwise for darker trails.

CONTROL 1 & CONTROL 2: The functions of these knobs vary depending on the selected reverb engine. Check the [Reverb Engines](#) section of this manual for the parameter descriptions of each CONTROL knob's function.

ENGINE SELECTOR KNOB: Selects between the 12 main effect engines. To access the additional reverb engines, use the Neuro Mobile App or Desktop Editor.

ON/OFF FOOTSWITCH: Engages or bypasses the reverb effect. The corresponding ON/OFF LED will be lit when the reverb effect is engaged. In addition (while the pedal is engaged), pressing and holding the ON/OFF Footswitch scrolls to the next Preset.

OPTION FOOTSWITCH (FOOTSWITCH #2): This dual action footswitch comes preloaded with two independent control functions that vary depending on the selected engine. The footswitch responds to two actions: quickly tapping, or press & hold. Each of the two actions prompts a different function. See the [Reverb Engines](#) section for descriptions of each default control function. Option Footswitch commands include tap tempo for the Pre-Delay or modulation, Hold, Build, A/B reverb toggling, and more. It is also possible to program alternative control options with the Neuro App or Desktop Editor.

A/B REVERB SELECTOR TOGGLE SWITCH: Selects between reverbs A, B, or A+B. Save two independent reverb effects (one for each processor) in each of the Ventris's 128 presets and use the A/B Toggle Switch to select which is active. Selecting A + B will engage both reverbs simultaneously. Note: the initial engagement position of this switch can be saved as part of a preset. Go to the [Editing and Saving Dual Engine Presets](#) section for complete instructions on dual reverb presets.

PRESET SELECT/SAVE BUTTON: Scrolls through the four user presets (or eight in Preset Extension Mode) saved in the Ventris. To save a preset into the currently selected spot, press and hold this button.

AUTOMATIC STEREO DETECTION: The Ventris monitors its Input and Output connections and configures itself to the appropriate stereo routing mode. It is also possible to override this and choose a custom routing mode using the Neuro Editors.

Connections

Input Side Connections



Input 1

INPUT 1 is the primary input for guitar, bass, or other instruments. It can also accept line-level inputs and will work in your amp's effect loop. Connect it to your instrument or other audio source using a mono (TS) 1/4" cable. Details about the allowed signal levels are available in the [Specifications](#) section.

Input 2

INPUT 2 is the secondary audio input for stereo sources, external effects loop input, or as the data connection to your mobile device when using the Neuro App.

- *Input 2 as an Audio Input:* The tip contact on INPUT 2 acts as a secondary input for guitar, bass, or other instruments. Connect your instrument (or the previous effect in the signal chain) using a mono (TS) 1/4" cable. The Ventris will automatically configure itself for stereo audio input. Other routing options are available using the Neuro App. For more information about stereo routing, refer to the [Stereo Operation](#) section.
- *Input 2 as an External Loop Return:* If the Ventris routing mode includes an external loop, OUTPUT 2 is the loop send and INPUT 2 is the loop return. Connect INPUT 2 to the output of the external effects loop using a mono (TS) 1/4" cable.
- *Input 2 as a Neuro App Data Input:* The ring contact on INPUT 2 acts as a data connection for the Neuro Mobile App. The Neuro App sends data to the pedal using your mobile device's headphone jack. Connect it to your mobile device using the included stereo (TRS) 1/8" to 1/4" cable. It can also accept daisy-chained Neuro data from another Neuro-compatible pedal in the chain, provided that a TRS cable is used. The audio signal (if applicable) will be on the tip contact

of the plug, and the Neuro App data will be on the ring contact. This allows audio and Neuro data to flow on the same cable.

MIDI Input

This is a standard 5-pin DIN connector that accepts MIDI control messages from external devices, including program change (PC) and continuous controller (CC) messages. Please email contact@sourceaudio.net regarding any questions about the Ventris Dual Reverb's MIDI implementation.

Output Side Connections



Output 1

This is the primary audio output. Connect it to your amplifier, recording interface, or the next device in your effects signal chain using a mono (TS) 1/4" cable.

Output 2

OUTPUT 2 can act either as an audio output, external loop output, or as the daisy-chain data connection for the Neuro App.

- *Output 2 as an Audio Output:* The tip contact on OUTPUT 2 acts as the secondary audio output. It carries an audio signal when the Ventris is configured with a signal routing that uses stereo outputs. Connect it to your amplifier, recording interface, or the next device in your effects signal chain using a mono (TS) 1/4" cable.
- *Output 2 as an External Loop Send:* If the Ventris is configured in a routing mode that includes an external loop, OUTPUT 2 is the loop send and INPUT 2 is the loop return. Connect OUTPUT 2 to the input of the external effects loop using a mono (TS) 1/4" cable.
- *Output 2 as a Neuro App Data Daisy-Chain Output:* The ring contact on OUTPUT 2 acts as a data connection for the Neuro App, passing data from the Ventris to the next Source Audio effect in your signal chain. You can daisy-chain the Neuro App data regardless of whether OUTPUT 2 is configured to output audio or not. Connect OUTPUT 2 to the next device's Neuro App Data input (usually INPUT 2) using a stereo (TRS) 1/4" cable. The audio signal (if applicable) will be on the tip

contact of the plug, and the Neuro App data will be on the ring contact. This allows audio and Neuro data to flow on the same cable.

MIDI Thru

This is a standard 5-pin DIN connector that echoes MIDI messages from the MIDI INPUT jack and sends them to other devices. The Ventris does not generate any of its own MIDI data, but it will copy and output any data it receives.

Power and Control Connections



DC 9V (Power)

Connect to the included 9 Volt DC power supply. If you would like to use a 3rd-party supply, the power supply must be **regulated** at 9 Volts DC (direct current), able to source at least 280 mA (milliamps) of current, and the plug should have a tip-negative, barrel-positive polarity.

USB

Connect to your computer (Mac or Windows) to the Ventris's USB port (denoted by the icon) using a standard mini USB cable. The Ventris is a class compliant USB device, meaning that it does not require any custom drivers. For more information about the Ventris's USB capabilities, refer to the [USB Section](#) of the User's Guide.

Control Input

The 3.5 mm CONTROL INPUT port connects to external control devices such as the Source Audio Tap Tempo Switch, Source Audio Dual Expression Pedal, Reflex Universal Expression Pedal, Neuro Hub, and Hot Hand Motion Controller. For more information, refer to the [Expression Pedal Input](#), [Hot Hand Input](#), and [Neuro Hub](#) sections of the User's Guide.

Expression/Switch Pedal Input

The PEDAL IN jack on the back panel connects to either an external passive expression pedal or footswitch. The PEDAL IN SWITCH allows the user to select which type of external controller is being used. Set to EXP for expression control or SWITCH for footswitch control. See the [External Control](#)

section for details.

Reverb Engines

The Ventris includes twelve onboard reverb effect engines, with additional engines available via the Neuro Mobile App or the Neuro Desktop Editor. Because of the wide tonal possibilities of each reverb engine in the Ventris Dual Reverb, it was necessary to arm the pedal with two variable knobs labeled CONTROL 1 and CONTROL 2. When a new reverb engine is selected, two engine specific parameters are automatically assigned to the CONTROL knobs.

The OPTION Footswitch also performs different functions depending on the selected engine. The footswitch responds to two types contact: quickly tapping the switch, or pressing and holding the switch. Each of the two contact types prompts a different function.

Below are descriptions of each reverb engine and how the CONTROL knobs and OPTION footswitch are configured respectively. Please note that it is possible to reassign different parameters to the CONTROL knobs and functions to the OPTION footswitch. Go to the [Neuro Sound Editor](#) section for details on the alternate functions for the CONTROL knobs and OPTION footswitch.

ROOM (0)

The ROOM engines capture the ambient reverberations of a real acoustic space. In contrast with the E-DOME engine (which offers a massive, arena-sized reverb) the ROOM engine can summon a variety of room sizes from a warm and intimate household room to a larger theatre sized space. Use the TIME, PRE-DELAY, and MIX knobs to alter the size and feel of your room.

CONTROL 1: *Bass* – Adjusts the level of the low-end frequencies on the wet signal. Turn the knob counter clockwise for a lighter reverb or clockwise for thicker, more bass-heavy sound.

CONTROL 2: *Mod Depth* – Adds a pitch modulation to the wet signal. Turn the knob fully counter-clockwise for zero modulation and clockwise to gradually increase the pitch depth. Note: The rate of the modulation can be adjusted with the RATE control in the Neuro Editor, or by tapping the OPTION footswitch when it is assigned to Modulation Rate.

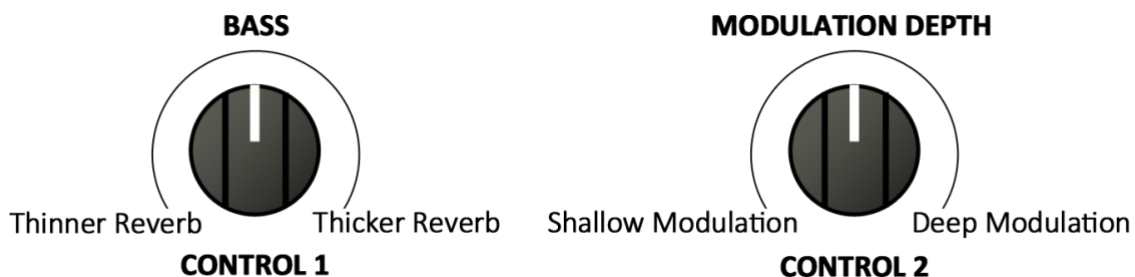

OPTION FOOTSWITCH (TAPPING): *Modulation Rate* – Works like a traditional tap tempo switch applied to the wet signal’s pitch modulation rate, meaning that tapping the OPTION footswitch in time with the band syncs the pedal’s pitch modulation rate to the music. Note: you must tap

the switch a minimum of two times for the Ventriss to change its modulation rate.

OPTION FOOTSWITCH (PRESS & HOLD): *Reverb Hold* – Sustains the reverb trail until the OPTION footswitch is released. This is a great way to sustain a chord and create a “pad,” as it is called in certain circles. While engaging the HOLD function, it is still possible to play on top of the sustained reverb trail with the reverb from the second processor (A or B) applied to the dry signal. Check the [Neuro Sound Editor](#) section for alternative HOLD configurations.

HALL (1)

Patterned after the lush sounds of studio rack units from the 80s, the Hall L engine is distinguished by its highly diffuse tones and glorious blooming characteristic. The Source Audio engineering time invested massive research time in perfectly capturing the complex sounds of these powerful effects units. It should be noted that though we place this grand effect engine among the classic reverbs, it has little resemblance to reverberations found in the natural or analog world, rather the Hall L replicates the extravagant wash of sound popular during the first wave of ambient music recordings.

CONTROL 1: *Bass* – See the description in the ROOM engine section.

CONTROL 2: *Hall Size* – Select between 5 different hall sizes. Turn the knob counter-clockwise for smaller, tighter hall sounds and clockwise to grander reverberations. Please note that this knob does not gradually increase the size of the hall, rather the knob is split into five regions. As you turn the knob you may hear the transition points where a new hall size is engaged.

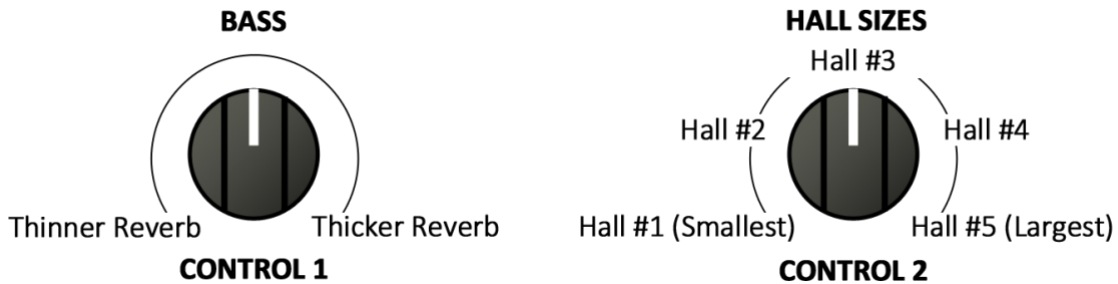

OPTION FOOTSWITCH (TAPPING): *Set Pre-Delay Time* – Works like a traditional tap tempo switch on a delay pedal. Pre-Delay Time is the amount of time between the dry signal and the first wave of reverb reflections (sort of like moving the time of an echo). So tapping the OPTION footswitch in time with the band syncs the echo effect to the beat of the music. Note: you must tap the switch a minimum of two times for the pedal to change the Pre-Delay Time.

OPTION FOOTSWITCH (PRESS & HOLD): *Reverb Hold* – See the description in the ROOM engine section.

E-DOME (2)

The cavernous E-DOME (a.k.a. “Enormo-Dome”) produces long, lush reverb trails that linger for days. Invoke the sound of massive, arena settings with the Ventriss Reverb’s largest room simulation. This one is huuuuge.

CONTROL 1: *Bass* – See the description in the ROOM engine section.

CONTROL 2: *Mod Depth* – See the description in the ROOM engine section

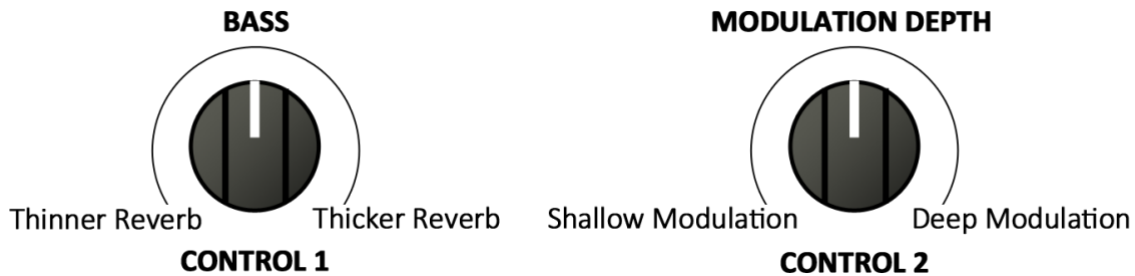

OPTION FOOTSWITCH (TAPPING): *Modulation Rate* – See the description in the ROOM engine section.

OPTION FOOTSWITCH (PRESS & HOLD): *Reverb Hold* – See the description in the ROOM engine section.

TRUE SPRING (3)

Source Audio’s Chief Scientist, Bob Chidlaw, worked long and hard to perfectly capture the sweet idiosyncrasies of a vintage spring reverb tank. The result is an exceptionally realistic effect with the unmistakable “drip” heard in vintage spring reverb equipped amplifiers.

CONTROL 1: *Bass* – Find the description in the ROOM engine section.

CONTROL 2: *Spring Length* – selects between three different virtual spring lengths. The longer the springs in a reverb tank the more distinguishable the “echo” effect becomes as the incoming signal travels back and forth across the length of the springs. Please note that this knob does not gradually increase the size of the springs, rather the knob is split into three regions. As you turn the knob you may hear the transition points when a new spring length is engaged.

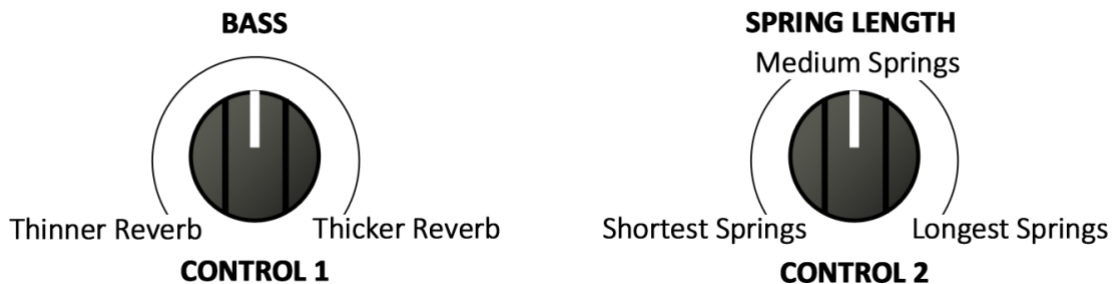

OPTION FOOTSWITCH (TAPPING): *Set Pre-Delay Time* – See the description in the HALL L engine section.

OPTION FOOTSWITCH (PRESS & HOLD): *Reverb Hold* – See the description in the ROOM engine section.

PLATE (4)

This authentic sounding reverb engine is a spot-on simulation of the highly diffuse effect synonymous with vintage plate reverb units of the 50s and 60s. Like the True Spring engine, Bob Chidlaw was relentless in crafting the perfect emulation of this beautiful and distinct sound. The critical component of a plate reverb is a large plate of suspended sheet metal. Blasting audio into the face of the sheet metal creates the beautifully lush and resonant tones found in countless classic recordings.

CONTROL 1: Bass – Find the description in the ROOM engine section.

CONTROL 2: Plate Size – Selects between three different plate sized: Small, Medium and Large. In general, as the plate size gets larger the reverberations will sustain longer and develop varying characteristics in the decay. Please note that this knob does not gradually increase the size of the plate, rather the knob is split into three regions. As you turn the knob you may hear the transition points when a new plate size is engaged.

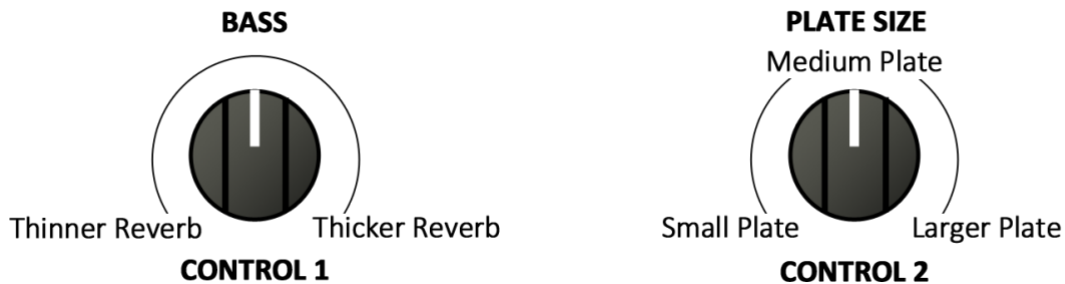

OPTION FOOTSWITCH (TAPPING): Set Pre-Delay Time – See the description in the HALL L engine section.

OPTION FOOTSWITCH (PRESS & HOLD): Reverb Hold – See the description in the ROOM engine section.

LO-FI (5)

This reverb effect turns the lush and grandiose effect of reverb on its head and embraces destructive elements like distortion and oversaturation. Turn up the ugly and create unique effects that add a layer of nastiness to your sound.

CONTROL 1: Distortion – Adjusts the amount of grit on the wet signal. Turn this knob clockwise to increase the amount of overdrive/fuzz added to the reverb tone. At the far right positions this knob begins to summon the qualities of a fuzz pedal.

CONTROL 2: Mod Noise Depth – Adjust the amount of sporadic modulation applied to the wet signal. Unlike the smooth and even Modulation found on many of the Ventris’s reverb engines, the Mod Noise Depth knob adds an irregular, non-symmetric pitch modulation. This style of modulation resembles the sound of a vintage tape delay that is possibly in need of repair.

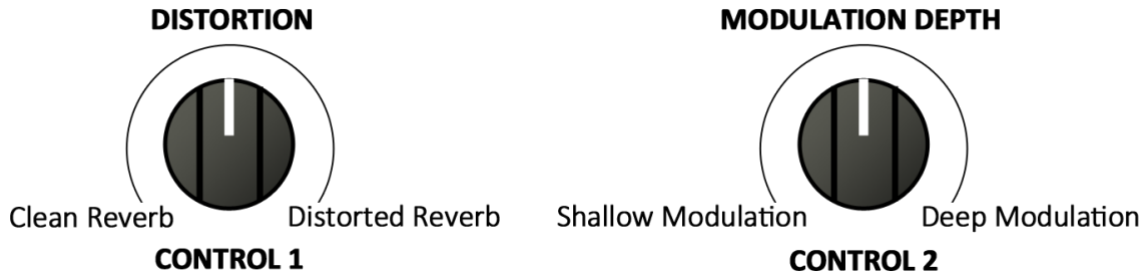

OPTION FOOTSWITCH (TAPPING): *Modulation Rate* – See the description in the ROOM engine section.

OPTION FOOTSWITCH (PRESS & HOLD): *Oscillate* – Unlike the normal Hold function that creates a constant reverb loop that doesn't change in volume or tone, the Oscillate function continuously routes the reverb signal back through the processor creating a sound that builds in intensity for a dramatic self-oscillation effect.

MODVERB (6)

This marvelously animated reverb engine perfectly captures the sound of tremolo and spring reverb hardware found in many vintage guitar amplifiers. But unlike those vintage amps, the Modverb engine can change the order of the signal path. Use the CONTROL 1 knob to choose between inserting the tremolo circuit before or after the spring reverb tank. It is also possible with the Neuro Editor to apply a tremolo effect to only the wet signal and leave your dry signal unaffected.

CONTROL 1: 10 Tremolo Select/Depth – Adjusts the depth of the tremolo effect and selects between two available reverb/tremolo signal paths. The knob is split into two regions. To the left of 12 o'clock, turning the knob clockwise increases the depth of a tremolo circuit placed prior to the reverb tank in the signal chain. To the right of 12 o'clock, turning the knob clockwise increases the depth of a tremolo circuit placed after the reverb tank in the signal chain, essentially applying a tremolo effect to the entire output signal. Please note that as you turn the knob you may hear the transition point when the knob passes the 12 o'clock position and changes regions.

CONTROL 2: Tremolo Rate – Adjusts the speed (or rate) of the tremolo effect. Turn the knob clockwise to increase the rate of the tremolo.

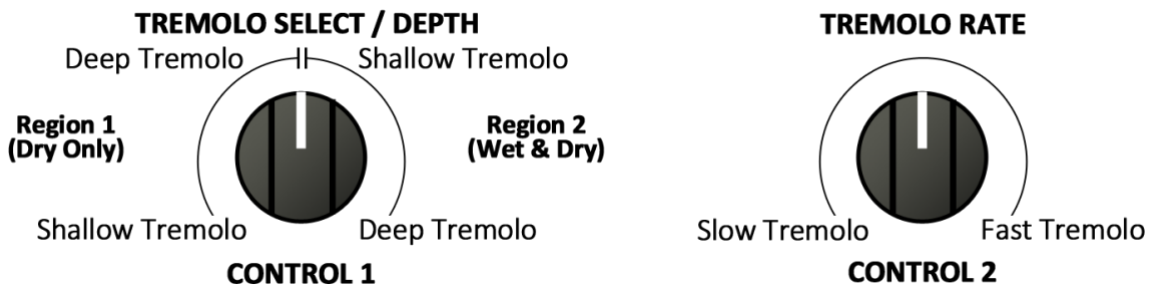

OPTION FOOTSWITCH (TAPPING): *Tremolo Rate* – Functions like a traditional tap tempo switch to set the speed of the tremolo effect. Tapping the OPTION footswitch in time with the band will

sync the tremolo to the music. Note: you must tap the switch a minimum of two times for the pedal to change the tremolo rate.

OPTION FOOTSWITCH (PRESS & HOLD): *Reverb Hold* – See the description in the ROOM engine section.

SHIMMER (7)

This pitch shifting reverb engine mixes traditional room sounds with octave-up reflections for an angelic reverb effect. Connect the Shimmer engine to the Neuro Desktop Editor and swap the octave-up for variety of additional pitch intervals.

CONTROL 1: Normal/Shimmer Crossfade – Controls the mix ratio between the normal reverb effect and the pitch shifting reverb reflections. Turn the knob clockwise to gradually increase the pitch shifting reverb and decrease the normal reverb in the wet mix.

CONTROL 2: Shimmer Regeneration – Increases the amount of Shimmer signal that is fed back into the reverb processor. To the listener, the Shimmer effect becomes more pronounced as this knob is turned clockwise.

NORMAL/SHIMMER CROSSFADE



SHIMMER REGENERATION



OPTION FOOTSWITCH (TAPPING): *Modulation Rate* – See the description in the ROOM engine section.

OPTION FOOTSWITCH (PRESS & HOLD): *Pitch Ramp Down* – Functions similar to the HOLD function except that as you press and hold the footswitch the Shimmer effect will slowly slip downward in pitch. It can be quite a haunting effect. Note: with the Neuro Editor it is also possible to send this pitch shift in an upward direction. **Expert Tip:** Try creating an A+B dual Shimmer preset with the OPTION footswitch on Reverb A set to a Pitch Ramp Down and Reverb B set to Pitch Ramp Up. Holding the OPTION footswitch yields a very interesting up/down pitch event. See the [Neuro Sound Editor](#) for instructions on reassigning the function of the OPTION Footswitch.

ECHOVERB (8)

This ambient combination of delay and reverb provides a sprawling echo effect with huge, reverberating repeats. The EchoVerb engine can also act as a classic delay pedal by turning the Delay/Reverb Crossfade knob to the full counter-clockwise position, thereby isolating the delay effect. The Echoverb engine has a maximum delay time of 2 seconds.

CONTROL 1: Delay Feedback – Controls the amount of delay signal that is fed back into the delay effect, thereby increasing the number of repeats. At the full counter-clockwise position the effect will generate a single delay repeat - as the knob is turned clockwise the repeats increase.

CONTROL 2: Delay/Reverb Crossfade – Adjusts the mix ratio between the delay and reverb signals. Set this knob to the full counter-clockwise position to hear only the delay effect. Turn the knob clockwise to gradually increase the reverb signal and decrease the delay signal in the wet mix. It is important to note that even when the CONTROL 2 is turned fully clockwise and only the reverb is audible, the reverb is still responding to the inaudible delay signal, which comes before it in the signal chain.

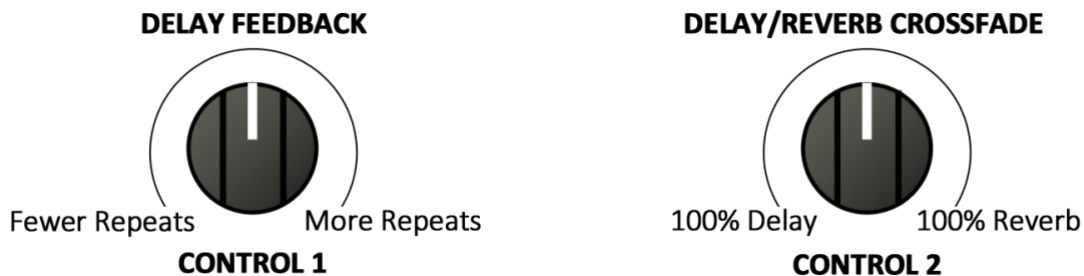

OPTION FOOTSWITCH (TAPPING): Delay Time – Functions similar to a traditional tap tempo switch on a delay pedal - tapping the OPTION footswitch in time with the band will sync the repeats to the beat of the music. Note: you must tap the switch a minimum of two times before the pedal changes the Delay Time.

OPTION FOOTSWITCH (PRESS & HOLD): Delay Hold – Creates a constant loop of the delay signal. While holding down the OPTION Footswitch the delay signal will continuously circulate without any changes in volume or tone.

SWELL (9)

Creates smooth, amorphous volume swells. This engine applies a volume swell effect to your instrument's dry signal, which is then fed into the reverb effect for super-long and ambient clouds of sound. This effect is great for creating soft, atmospheric chord pads. The Swell engine also sounds fantastic when it is placed first in a dual reverb preset set to Series Mode (A+B on the A/B Reverb Toggle Switch).

CONTROL 1: Envelope Gain – Controls the sensitivity of the envelope follower. Turn this knob down if you have low impedance pickups or you want to dig in with some hard picking, turn it up for high impedance pickups or soft picking.

CONTROL 2: Swell Time – Adjust the speed of the volume swell. Turn the control counter-clockwise for quicker swells and clockwise for a longer, smooth effect.

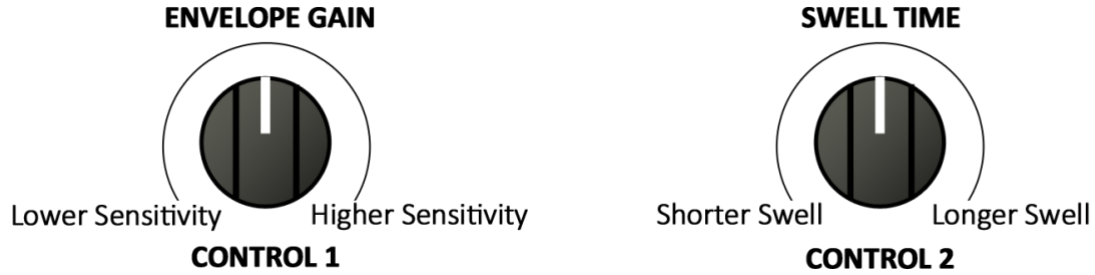

OPTION FOOTSWITCH (TAPPING): *Modulation Rate* – See the description in the ROOM engine section.

OPTION FOOTSWITCH (PRESS & HOLD): *Reverb Hold* – See the description in the ROOM engine section.

OFFSPRING (10)

Nothing else sounds like the Offspring reverb. This unique and dramatic effect falls somewhere between the sound of an angel’s harp and a retro-futuristic sci-fi soundtrack. In truth the Offspring engine uses all-pass filters to extract cascading frequency bands, creating an effect similar to an arpeggiator. It appears complicated, but it is really quite musical and sounds very nice with a variety of different playing styles.

CONTROL 1: *Bass* – Find the description in the ROOM engine section.

CONTROL 2: *Modulation Depth* – See the description in the ROOM engine section.

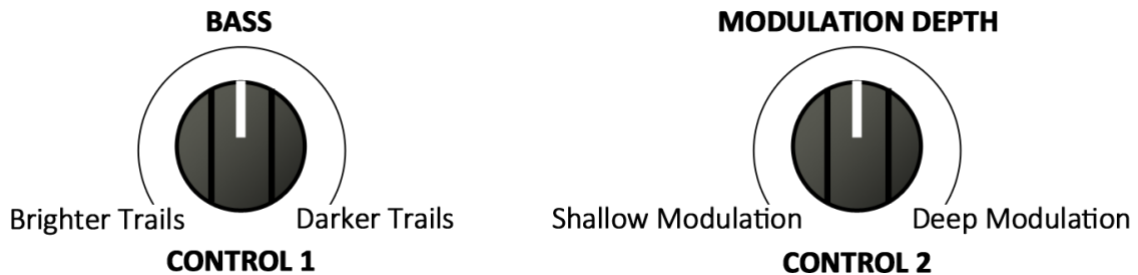

OPTION FOOTSWITCH (TAPPING): *Repeat Time* – Functions like a traditional tap tempo switch applied to the Offspring’s unique style of repeats.

OPTION FOOTSWITCH (PRESS & HOLD): *Reverb Hold* – See the description in the ROOM engine section.

REVERSE (11)

Create chilling and dramatic backwards effects with this haunting reverb engine. Set the MIX knob to 100% wet for a menacing sound surge or mix it with the dry signal for an unnerving shadow effect.

CONTROL 1: *Diffusion* – Use this knob to smooth (or “smear”) the surging reverse effect. Turning the knob fully clockwise produces a smooth reverse effect, while turning the knob in the

counter-clockwise direction creates an interesting granular effect with distinct attack transients.

CONTROL 2: Mod Depth – Find the description in the ROOM engine section.

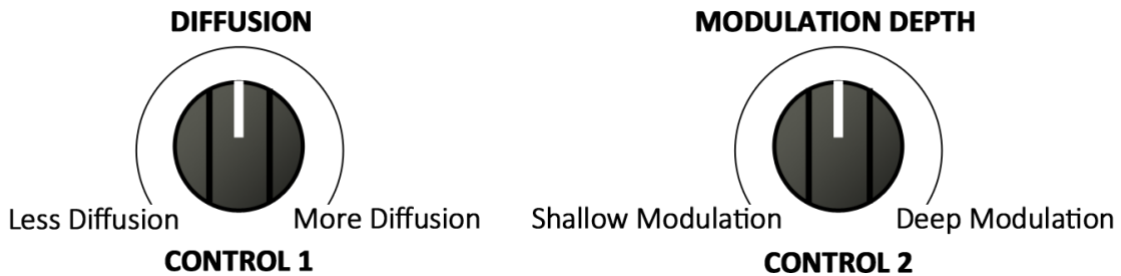

OPTION FOOTSWITCH (TAPPING): *Rise Time & Modulation Rate* – Functions like a traditional tap tempo switch applied to the length of time it takes for the reverse effect to reach its point of attack and the rate of the pitch modulation.

OPTION FOOTSWITCH (PRESS & HOLD): *Reverb Hold* – See the description in the ROOM engine section.

Extended Reverb Engines

On top of the twelve reverb engines available on the front panel, the Neuro Mobile App and Desktop Editor include a dynamic collection of additional reverb engines. These engines offer a variety of tonal options and can be used to overwrite the default engines on the effect dial or stored as user presets. The following reverb engines are available in the Neuro Desktop Editor or Mobile App:

OUTBOARD SPRING (12)

Like the True Spring engine, Outboard Spring replicates the sound of a classic spring reverb. But Outboard Spring was inspired by the sound of intensely crafted outboard spring tanks, like the Fender 6G15 or the more contemporary SurfyBear Reverb. The most notable characteristic of outboard spring units is their intense “drip,” a distinct drippy sound heard in the early reflections of the physical springs. It is a sound sought after by surf rock guitarists from coast to coast.

CONTROL 1: *Bass* – Find the description in the ROOM engine section.

CONTROL 2: *Drive (a.k.a. “Dwell”)* – Increases the intensity at which the dry signal hits the virtual springs. Increasing the Drive causes the springs to reverberate a bit more dramatically and also intensifies the “drip.”

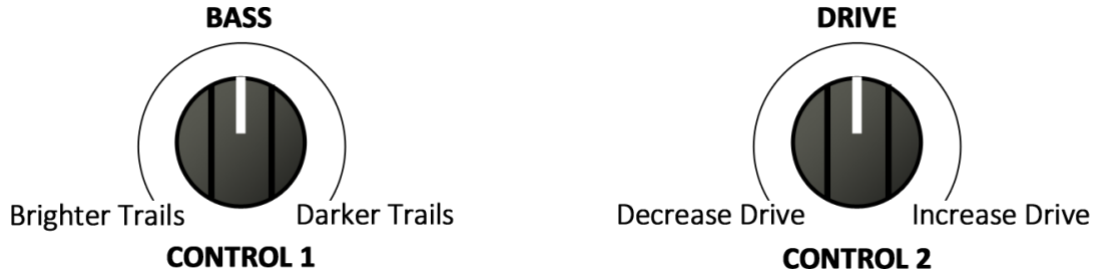

OPTION FOOTSWITCH (TAPPING): *Pre-Delay Time* – Functions like a traditional tap tempo switch applied to the Pre-Delay Time, essentially creating a time synced echo effect.

OPTION FOOTSWITCH (PRESS & HOLD): *Reverb Hold* – See the description in the ROOM engine section.

METAL BOX (13)

Direct from the mind of Bob Chidlaw (Source Audio’s Chief Scientist of Sound), the Metal Box captures the reverberations of a very small space with extremely reflective walls – imagine your guitar amp in a metal cargo-shipping container. It’s wild to imagine, ever wilder to hear. Turn up the Modulation and turn down the reverb Time to create an interesting chorus effect.

CONTROL 1: *Bass* – Adjusts the level of the low-end frequencies on the wet signal. Turn the knob counter clockwise for a lighter reverb or clockwise for thicker, more bass-heavy sound.

CONTROL 2: *Mod Depth* – Adds a pitch modulation to the wet signal. Turn the knob fully counter-clockwise for zero modulation and clockwise to gradually increase the pitch depth. Note: The rate of the modulation can be adjusted with the RATE control in the Neuro Editor, or by tapping the OPTION footswitch when it is assigned to Modulation Rate.

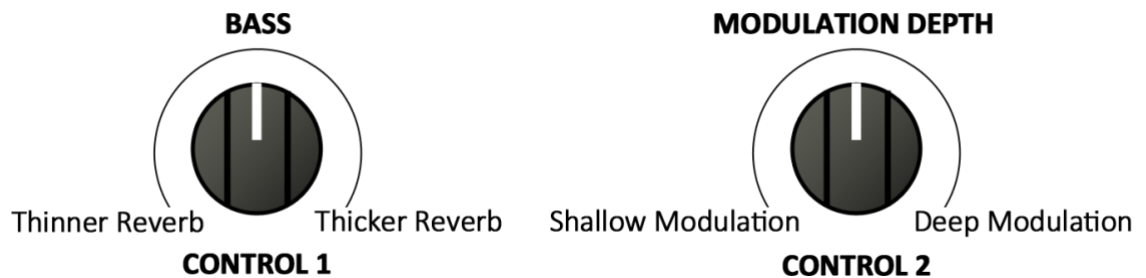

OPTION FOOTSWITCH (TAPPING): *Pre-Delay Time* – Functions like a traditional tap tempo switch applied to the Pre-Delay Time, essentially creating a time synced echo effect.

OPTION FOOTSWITCH (PRESS & HOLD): *Reverb Hold* – Sustains the reverb trail until the OPTION footswitch is released.

Controls



Time Knob

Sets the sustain time of the reverb trail. Turning the TIME knob to the fully clockwise position causes the reverb trail to sustain infinitely. However, unlike the HOLD function (which creates a steady reverb loop), setting the TIME knob set to infinite sustain will create a degenerating effect over time as the reverb continues to circulate and receive additional dry signal. The results can be a bit cacophonous, but it will create a very interesting effect.

Mix Knob

Sets the relative levels of dry signal and wet reverb signal. Fully counter-clockwise is 100% dry, fully clockwise is 100% wet. Roughly 3 o'clock on the MIX knob is where a 50/50 split between wet and dry occurs. Please note that Kill Dry Mode is also available as a global option (see Kill Dry Mode in the Neuro [Hardware Options](#) section of this manual).

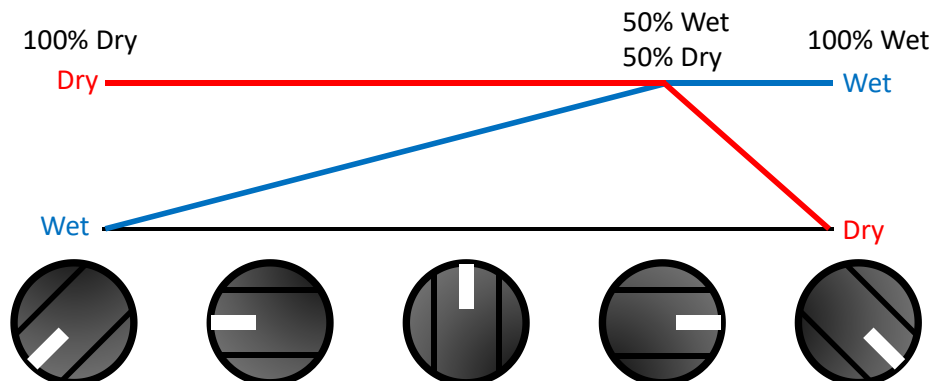

Please note that when the A/B Reverb Toggle Switch is set to the A+B position, the function of MIX and CONTROL 1 & 2 change. In A+B mode the CONTROL 1 knob adjusts the wet level of reverb A, CONTROL 2 adjusts the wet level of reverb B, and the MIX knobs adjusts the level of the dry signal.

Using the Mix Knob to Set Master Output Level

The overall output volume level is adjustable on the pedal hardware without needing to use Neuro Editing Software or MIDI. Press and hold the CONTROL INPUT button and then turn the MIX knob to set the master output level, which affects both the wet signal and the dry signal. A maximum of +6 dB of boost is possible. The following figure shows the range of output gains, in decibels (blue) and linear (red). Note that when the output level is adjusted, it will be maintained while changing effect engines using the effect dial. Loading a user preset will override the level set by the MIX knob.

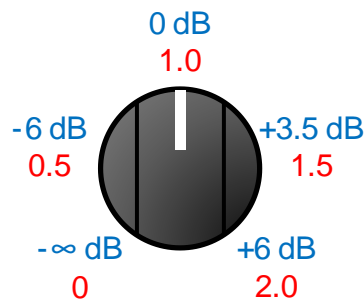

Pre-Delay Knob

Sets the amount of time between the dry signal and the initial reverb reflections. As the PRE-DELAY knob is turned clockwise the pre-delay time increases creating a sound similar to a natural echo or “slapback” effect.

Treble Knob

Controls the amount of high frequency damping applied to the wet signal. Turn the knob clockwise for a brighter reverb trail and counter-clockwise for a darker reverb.

Control 1 and Control 2

Because of the wide tonal possibilities of each reverb engine in the Ventriss Dual Reverb, it was necessary to arm the pedal with two “wildcard” knobs labeled CONTROL 1 and CONTROL 2. The function of the CONTROL knobs varies depending on the active reverb engine. Details on the function of each knob are available in the [Reverb Engines section](#) of this manual. It is also possible to assign alternate parameters to the CONTROL 1 & 2 knobs. CONTROL knob reassignments can be saved to individual presets or to any of the engines on the EFFECT SELECTOR knob. Go to the [Neuro Sound Editor](#) section for details on assigning alternate CONTROL knob parameters.

Please note that when the A/B Reverb Toggle Switch is set to the A+B position, both Reverbs A and B are running simultaneously and the function of the MIX and CONTROL 1 & 2 knobs change. When running the reverbs in Parallel, CONTROL 1 sets the wet level of Reverb A, CONTROL 2 sets the wet level of Reverb B, and MIX sets the level of the dry signal. When running the reverbs in Series (a.k.a. “Cascade”), CONTROL 1 sets the wet/dry mix of Reverb A, CONTROL 2 sets the wet/dry mix of Reverb B, and MIX sets the level of the dry signal. See the [Editing and Saving Dual Engine Presets](#) section for complete instructions on dual reverb presets.

Effect Engine Selector Encoder

This is the reverb engine selector. It determines the overall engine and sets the function of the CONTROL knobs and OPTION footswitch.

Effect Engine Selector LEDs

The REVERB ENGINE LEDs that encircle the ENGINE SELECTOR indicate which engine is currently active. This works for the first 12 effect engines. If a user has activated one of the extended engines then none of these REVERB ENGINE LEDs will be lit. If the Reverb Selector toggle switch is set to A+B, both of the selected engine LEDs will illuminate. If reverbs A and B are both programmed with the same reverb engine and the Reverb Selector is set to A + B, the appropriate single LED will illuminate with a double blinking pattern.

It is possible, using the Neuro App, to replace one of the default engines on the engine selector wheel with another engine. If the user has done this, the corresponding LED will blink to show that the engine does not match the name written in ink on the face of the Ventris. This is also true in A + B mode.

A/B Reverb Toggle Switch

The Ventris Dual Reverb features two completely independent 56-bit signal processors. The two processors give the Ventris the ability to simultaneously save two reverb sounds in each of the pedal's 8 onboard or 128 MIDI accessible presets. The A/B Reverb Toggle Switch provides easy access to each of the individual Reverbs (A or B) as well as a combination of the two (A+B).

Selecting positions A or B enables the reverb effect that was programmed to the corresponding toggle position. Selecting position A+B enables both reverbs simultaneously. By default the A+B toggle position will run the reverbs in parallel and mix them together (in stereo) to the Outputs. It is also possible to run the reverbs in Cascade Mode, one into the other. To cascade the reverb engines, first flip the toggle switch to either the A or B position, hold down the CONTROL INPUT button (at the top of the pedal), and switch the toggle back to the A + B position – now Reverb A will cascade into Reverb B. To switch back to Parallel mode, repeat the process WITHOUT holding down the CONTROL INPUT button.

When the A+B toggle position has been selected certain knob functions are altered. When running the reverbs in Parallel Mode, CONTROL 1 sets the wet level of Reverb A, CONTROL 2 sets the wet level of Reverb B, and MIX sets the level of the dry signal. When running the reverbs in Series Mode, CONTROL 1 sets the wet/dry mix of Reverb A, CONTROL 2 sets the wet/dry mix of Reverb B, and MIX sets the level of the dry signal. See the [Editing and Saving Dual Engine Presets](#) section for complete instructions on dual reverb presets.

Any of the three toggle switch positions can be individually assigned as the initially engage position for each of the 128 presets. Note: if the A+B toggle position is used during preset switching (in either the former or later preset), the Spillover function is not available.

On/Off Footswitch

Enables or bypasses the reverb effect. By default the Ventris uses a True/Hard Bypass Mode, but it is also possible to switch to a Buffered Bypass (see the [Universal Bypass](#) section for more information) or Trails Mode Bypass (see the Trails Mode section).

The ON/OFF Footswitch also serves a second function. When the effect is engaged, pressing and holding the ON/OFF footswitch will scroll upward through the user presets. Releasing the switch will stop the scrolling and engage the preset saved to the illuminated PRESET SELECT LED.

Trails Mode

By default the Ventriss is set to Hard Bypass Mode, which means that the reverb trails will stop immediately upon bypassing the pedal. Trails Mode (also known as “Soft Bypass”) is an optional bypass mode that allows the reverb trails to fade out naturally after the effect has been bypassed.

Trails mode can be enabled from the [Hardware Options](#) menu of the Neuro Mobile App or Desktop Editor. It is also possible to put the pedal into Trails mode by pressing the ON/OFF FOOTSWITCH while holding the CONTROL INPUT BUTTON. This will toggle between enabling and disabling trails mode and the setting will be saved automatically. Trails Mode is a **global** setting and is NOT saved per preset.

On/Off LED

The ON/OFF LED above the ON/OFF FOOTSWITCH indicates if the reverb effect is active (lit green) or bypassed (not lit).

If trails mode is active, the ON/OFF LED will be lit green when the reverb effect is active and lit red when the reverb effect is bypassed.

Option Footswitch

Because of the range of functions that can be controlled with the OPTION Footswitch, we felt it necessary to assign different default functions to this footswitch depending on the selected engine. The switch responds to two actions: **quickly tapping** or **press and hold**. Each of the two actions will prompt a different function. In addition to the default functions, it is also possible to reassign alternate functions to the footswitch via the Neuro Editors. See the [Neuro Sound Editor](#) section for a list of control choices.

Also, when the Ventriss is bypassed the OPTION footswitch doubles as preset scroller. In Bypass Mode, tapping the OPTION footswitch scrolls upward through the user presets and pressing and holding the switch scrolls downward through the presets. The matrix below provides a quick overview of the basic functions of each footswitch in the engaged and bypassed states.

Default
“out of the box”
Footswitch
Functions



Action	Pedal State	ON/OFF Switch	OPTION Switch
Tapping	Bypass	On	Preset Up
Tapping	Engaged	Off	Engine Dependent*
Press and Hold	Bypass	Not Available	Preset Down
Press and Hold	Engaged	Preset Up	Engine Dependent*

OPTION Footswitch Functions

The default control assignments of OPTION footswitch are set to provide an intuitive and effective experience without making any modifications. The graphic below provides a brief overview of the default (“out-of-the-box”) control assignment per reverb engine.

Default “out of the box”
OPTION Footswitch Action



Reverb Engine	Tapping	Press and Hold
ROOM	Mod. Rate	Reverb Hold
HALL L	Set Pre-Delay Time	Reverb Hold
E-DOME	Mod. Rate	Reverb Hold
TRUE SPRING	Set Pre-Delay Time	Reverb Hold
PLATE	Set Pre-Delay Time	Reverb Hold
LO-FI	Mod. Rate	Oscillate
MODVERB	Tremolo Rate	Reverb Hold
SHIMMER	Mod. Rate	Pitch Ramp Down
ECHOVERB	Delay Tap Tempo	Delay Hold
SWELL	Mod. Rate	Reverb Hold
OFFSPRING	Repeat Time	Reverb Hold
REVERSE	Rise Time + Mod. Rate	Reverb Hold

Reverb Hold Function with Dual Processor Architecture

One of the great advantages of the Ventriss Dual Reverb’s dual processor architecture is the opportunity it offers to the Hold function. With the Ventriss the Hold function sustains the wet signal indefinitely while pressing down on the OPTION footswitch. As with most effects units that offer some type of a Hold (a.k.a. “Freeze”) function, it is also possible to continue playing over the top of the sustained reverb tail. The problem with most pedals, however, is that when you are sustaining the reverb tail, reverb is no longer being applied to the dry signal as you play over the top. That is not the case with the Ventriss Dual Reverb – because of the dual processors; it is possible for the second processor to engage while sustaining the first. For example while sustaining the tail of Reverb A, Reverb B will be applied to the dry signal. It is also possible (by selecting “Hold Other Engine” in the [Option Press and Hold](#) dropdown menu of the Neuro Desktop Editor) to summon and hold the trail of

the Reverb not currently in use. For example, you can play through Reverb A, the press the OPTION switch to summon and hold the trail of Reverb B – all the while maintaining the undisturbed reflections of Reverb A (See the illustration below for additional clarity).

Toggle = A

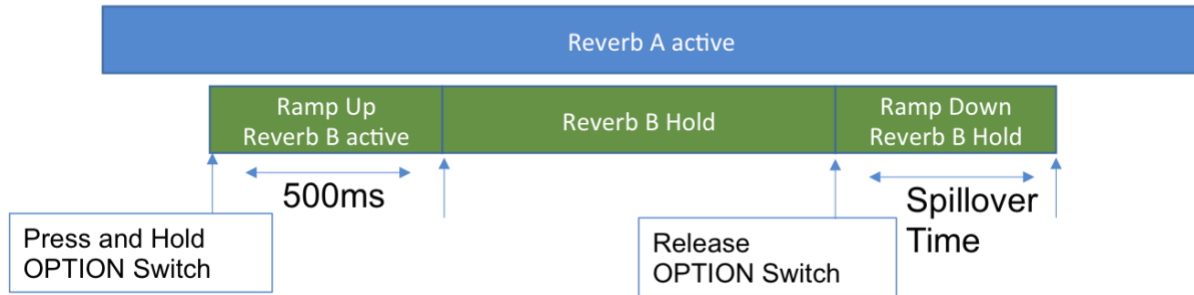

“Hold Other Engine” Function (Holding Reverb B)

Option LED

The OPTION LED (located above the OPTION Footswitch) indicates the Pre-Delay time or LFO rate when using the OPTION Footswitch as a Tap Tempo control. When the OPTION footswitch controls Tap Tempo of Pre-Delay, the LED will blink in time. When Tap Tempo controls the rate of modulation effects, the LED will employ a smooth pulsing illumination. The LED also illuminates solidly when the HOLD or BUILD functions are engaged.

Control Input Button

This small button located at the top of the pedal is used when configuring external control. See the [External Control](#) section for more details.

External Control LED

The small LED located to the left of the MIX KNOB is the CONTROL/ACTIVITY LED. When lit, it indicates that external control mode (expression or MIDI) is active or that incoming data is being received via MIDI or a Neuro connection. For more information, see the [External Control](#) section.

Preset Select/(Hold) Save Button and LEDs

Press the SELECT button to scroll through and select saved user presets. The four PRESET LEDs next to the PRESET BUTTON indicate which preset is active for presets 1 through 4. If a preset has been modified, the corresponding PRESET LED will blink slowly. To save a preset, press and hold this button – the associated preset LED will blink for a few seconds. When the LED stops blinking, the updated preset will be saved to the current preset position.

Preset Extension Mode: Allows for easy access to an additional 4 presets for a total of 8 onboard presets. To enable Preset Extension Mode, go to the Hardware Options sections of the Neuro Mobile or Desktop Editor (see [Neuro Hardware Options](#)) and select the appropriate option. The illumination patterns of the Preset Select LEDs indicate which Preset has been selected (see the figure below).

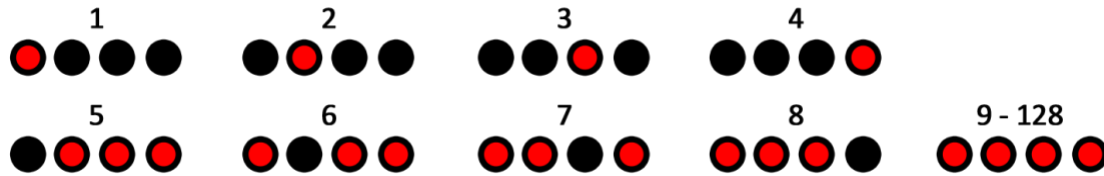

Note: when using a MIDI controller to select a preset outside of the normal bank (presets 1 to 4) or extended bank (presets 5 to 8), then all 4 PRESET LEDs will be lit, indicating that a preset in the range between 9 and 128 is active. For details on preset editing and saving, see the next section.

Preset Storage and Recall

User Presets store all user editable parameters. This includes the knob positions, current effect engines, routing options, external control, and the full list of Neuro/MIDI accessible parameters. Included in every preset are settings for each position on the A/B Reverb Toggle Switch (Reverb A, Reverb B, and Reverbs A+B (Dual Mode)). It is also possible to specify which A/B Reverb Toggle Switch position initially engages: A, B, or A+B. After a preset is recalled, you can always tweak it in a performance situation by turning a knob. The knob parameter will then “jump” to the knob position as the knob is moved.

Recalling Presets

The first 4 User Presets (or 8 in Preset Extension Mode) are accessible via the onboard hardware or with and external footswitch in the following ways:

1. Click the SELECT button to cycle through the hardware user presets. This function works whether the pedal is engaged and bypassed.
2. When the pedal is engaged, press and hold the ON/OFF Footswitch to scroll upward through user presets
3. When the pedal is bypassed, tap the OPTION Footswitch to scroll upward through the user presets, or press and hold the OPTION Footswitch to scroll downward through user presets.
4. Connect an external footswitch to the PEDAL IN jack and select SWITCH mode (located next to the PEDAL IN jack) to scroll upward through presets. Please note that it is possible to reassign the function of external single and dual footswitches in the [Hardware Options](#) section of the Neuro Desktop or Mobile App Editors – these control assignments are global.

Recalling MIDI Presets

All 128 available User Presets are accessible with an external MIDI controller. MIDI controllers can be connected via either the 5-Pin DIN (MIDI IN) jack on the side of the pedal, the USB port at the top of the pedal, or through a Neuro Hub, which connected to the CONTROL INPUT at the top of the pedal. All 128 User Presets can be recalled with the corresponding MIDI program change (PC) messages.

Editing and Saving a Single Engine Preset to Reverb A

In most cases it is only necessary to use a single engine when creating a reverb preset. Follow the procedure below to create a traditional single engine Preset to position A on the A/B Reverb Toggle

Switch. Within each of the 128 Presets the adjustable settings include reverb engines, knob and Neuro parameters, routing options, and external control options.

1. Select the preset you would like to edit by clicking the SELECT/(HOLD) SAVE Button until the corresponding PRESET LED is lit. When using MIDI, select the preset with the corresponding MIDI program change (PC) message.
2. Move the A/B Reverb Toggle Switch to position A and use the knobs or Neuro App/MIDI to set up the sound to your liking. The PRESET LED will begin to blink, indicating that the preset is being edited.
3. Press and hold the SELECT/(HOLD) SAVE Button. Continue holding the SELECT/(HOLD) SAVE until the PRESET LED blinks fast, then slow, and eventually turns solid. This indicates that the preset has been saved. To copy a preset from one location to another, see the [Copying a Preset section](#) below.

*Note: To save a preset to the position B on the A/B Reverb Toggle Switch, follow the same process, but select toggle switch position B in step 2.

Editing and Saving a Dual Engine Preset to Reverb A+B

Within each of the 128 Presets available on the Ventris Dual Reverb it is possible to save an entirely different collection of settings for both the A and B Reverbs. It is also possible to combine two reverbs by selecting the A+B position on the A/B Reverb Toggle Switch.

It should be noted that there are two signal routing modes available when creating dual reverb presets (A+B): Parallel Mode and Cascade (a.k.a. Series) Mode. The differences are as follows:

- **Parallel Mode:** By default Reverb A+B runs in Parallel Mode. Parallel Mode routes Reverb A and Reverb B side-by-side, then combines them for the final mono or stereo output signal. In A+B/Parallel Mode the functions of the CONTROL 1, CONTROL 2, and MIX knobs change: CONTROL 1 sets the wet level of Reverb A, CONTROL 2 sets the wet level of Reverb B, and MIX sets the level of the dry signal. The figure below illustrates the Parallel/A+B signal path and altered knob functions.

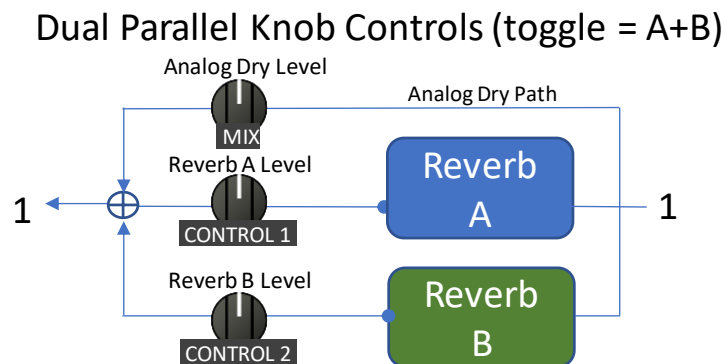

- **Cascade Mode:** (a.k.a. “Series Mode”): Cascade Mode is the alternate dual reverb mode. It routes Reverb A and B in series, Reverb A cascading into Reverb B. This Mode functions just as if you were running one reverb pedal into another in a traditional pedalboard signal chain. To enter Cascade Mode switch the A/B Reverb Toggle Switch to position A, hold down the

CONTROL INPUT button then switch the Toggle Switch back to A+B (To switch back to Parallel Mode, repeat the process without holding down the CONTROL INPUT button). When combining the reverbs in Cascade Mode, CONTROL 1 sets the wet/dry mix of Reverb A, CONTROL 2 sets the wet/dry mix of Reverb B, and MIX sets the level of the dry signal. The figure below illustrates the Cascade/A+B signal path and altered knob functions.

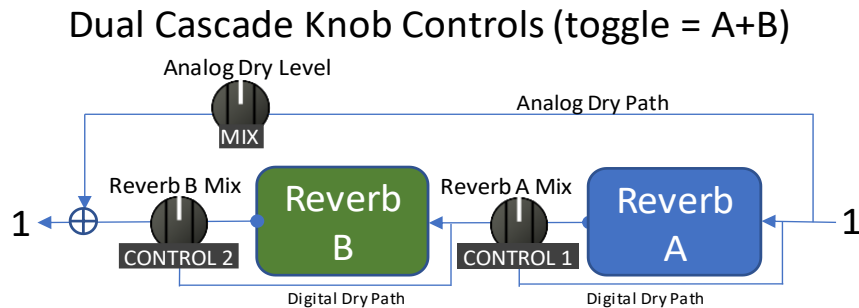

Follow the instructions below to create dual reverb presets:

1. Select the preset you would like to edit by clicking the SELECT/(HOLD) SAVE Button until the corresponding PRESET LED is lit.
2. Select Reverb A with the A/B Reverb Toggle Switch and dial in your settings with the front panel controls or Neuro Editor.
3. Flip the A/B Reverb Toggle Switch to Reverb B and dial in the settings for Reverb B. Please note that it is possible to use different reverb engines in Reverbs A and B.
4. Flip the A/B Reverb Toggle Switch to A+B. By default the A+B reverb is routed in parallel, if you wish to run your Reverbs in series (Note: Reverb A always cascades into Reverb B), flip back to Reverb A, press and hold the CONTROL INPUT button at the top of the pedal, and switch the toggle back to A+B. The A and B Reverbs will now run in series. To switch back to Parallel Mode, repeat the process without holding down the CONTROL INPUT button.
5. In A+B Mode the functions of the CONTROL 1, CONTROL 2, and MIX knobs change. When running the reverbs in Parallel, CONTROL 1 sets the wet level of Reverb A, CONTROL 2 sets the wet level of Reverb B, and MIX sets the level of the dry signal. When routing the reverbs in Cascade Mode, CONTROL 1 sets the wet/dry mix of Reverb A, CONTROL 2 sets the wet/dry mix of Reverb B, and MIX sets the level of the dry signal. In A+B Mode, the TIME, PRE-DELAY and TREBLE knobs will override the knob positions selected in steps 2 and 3.
6. Select the A/B Reverb Toggle Switch position to which you would like the Preset to initially engage (A, B, or A+B).
7. Press and hold the SELECT/(HOLD) SAVE Button. Continue holding the SELECT/(HOLD) SAVE until the PRESET LED blinks fast, then slow, and eventually turns solid. This indicates that the preset has been saved. To copy a preset from one location to another, see the [Copying a Preset](#) section below.
8. **Note:** It is also possible to route A+B Reverb Presets so that Reverb A routes exclusively to Output 1 and only Reverb B routes exclusively to Output 2 – this is called “Independent Stereo Mode” and it is one of the alternate routing options available via the Neuro Editor. Go to the [Neuro Sound Editor](#) section for more info on Independent Stereo modes.

Note: When recalling presets via MIDI PC messages, you may wish to queue up your preset with effect bypassed. To do this, simply engage the preset, bypass it with the ON/OFF footswitch, then re-save the preset normally. When recalled, the pedal will load the saved user settings, but the effect will be bypassed. To engage the preset, simply press the ON/OFF Footswitch on the Ventris.

Copying a Preset to a New Location Using the Select/(Hold) Save Button

1. Select the preset you would like to copy by pressing the SELECT/(HOLD) SAVE Button until the corresponding PRESET LED is lit.
2. Press and hold the SELECT/(HOLD) SAVE Button for one second until the corresponding PRESET LED begins blinking rapidly. Quickly release the SELECT/(HOLD) SAVE Button. The PRESET LED should continue to blink rapidly. This indicates that the Ventris is in copy mode.
3. Tap the SELECT/(HOLD) SAVE Button to increment the preset. The corresponding PRESET LED should continue to blink rapidly. Tap the SELECT/(HOLD) SAVE Button again until the desired copy destination is selected.
4. Press and hold the SELECT/(HOLD) SAVE Button until the PRESET LED blinks slowly and then turns solid. This indicates that the preset has been saved to the new location. The original location will not be changed or overwritten.

Copying a Preset to a New Location Using an External MIDI Controller

1. Select the preset you would like to copy by sending a MIDI program change message to the Ventris.
2. Press and hold the SELECT/(HOLD) SAVE Button for one second until the corresponding PRESET LED begins blinking rapidly. Quickly release the SELECT/(HOLD) SAVE Button. The PRESET LED(S) should continue to blink rapidly. This indicates that the Ventris is in copy mode.
3. Send a desired MIDI Program Change number to indicate the desired copy destination for the preset.
4. PRESET LED will blink fast and then turn solid. This indicates that the preset has been saved to the new location.

Copying a Preset to a New Location Using the Neuro App

Using the BURN command in Neuro Mobile or Desktop Editors, it is possible to copy presets to any location in memory.

Clearing all Presets

The entire range of 128 User Presets can be erased using the Factory Reset procedure. Warning: the Factory Reset procedure resets the entire pedal back to the state in which it was originally shipped – this includes all global settings, swapped reverb engines in the Effect Selector knob, and User Presets. A Factory Reset will not change any firmware updates.

Universal Bypass

Most effect pedals offer either true bypass or buffered bypass. The Ventriss contains two separate circuits for bypass mode, allowing you to choose the method you prefer. The true bypass path uses signal relays, which are electromechanical switches. This provides an ultra-low resistance path from the input jacks to the output jacks, which is effectively the same as a wire. The buffered bypass path uses extremely low noise buffers, which provide a very low output impedance and are effective for driving long cables or long chains of effects following the Ventriss's audio output.

Out of the box, the Ventriss operates in true bypass mode. In order to switch to buffered bypass mode, edit the Ventriss Reverb's **global settings** using the Neuro Desktop or Mobile App.

We recommend you choose between the active analog bypass (a.k.a. buffered bypass) and relay-based true bypass based on what is needed in your signal chain. Ideally, on a larger pedalboard the first pedal in a signal chain is a buffered input followed by true bypass in the rest of the signal chain.

Both bypass methods have pros and cons associated with them. Buffered bypass provides consistent input impedance so that if the source is susceptible to variations in input impedance (similar to a guitar pickup), there won't be a noticeable change in tone. True bypass has the benefit of providing a dedicated hardwired bypass signal path. The Ventriss features small-signal relays for true bypass switching that offer reduced pops and clicks compared to the traditional true bypass switching method using a mechanical switch.

When using Trails Mode, a function called "soft bypass" is used in order to maintain the reverb trails after the effect has been bypassed. Trails Mode sends the audio through the DSP at all times so the Ventriss must remain in the buffered bypass path. Select the Reverb Trails Mode option in the Hardware Options page of the Neuro Desktop or Mobile App to put the Ventriss into Trails Mode.

Stereo Operation & Signal Routing

The Ventriss Dual Reverb creates dramatic mono or stereo effects via its stereo Input and Output jacks. By default, the Ventriss auto-detects the cables connected to INPUTS and OUTPUTS 1 & 2 and engages the appropriate Routing Mode. In addition, the Neuro Editors offer a variety of alternate signal routing modes including Independent Stereo Out (a different reverb engine assigned to each of the Outputs), Mono Out/Dry Out (one Output assigned to a reverb engine, the other Output dry), and External Loop Modes (insert an external effect within the pedal's effects loop). Go to the [I/O Routing Options](#) section in the Neuro Desktop Editor for details on implementing signal routing.

Auto Routing and Default Modes

By default, the Ventris detects what has been plugged into its inputs and outputs and sets the routing mode automatically. The table below summarizes each Auto Routing Mode and its corresponding cable connections.

INPUT 1	INPUT 2	OUTPUT 1	OUTPUT 2	Resulting Auto Routing Mode
Connected		Connected		Mono in, Mono Out, Dual Parallel
Connected	Connected	Connected		Stereo in, Mono Out, Dual Parallel
Connected		Connected	Connected	Mono in, Stereo Out, Dual Parallel
Connected	Connected	Connected	Connected	Stereo in, Stereo Out, Dual Parallel

Please note that by default switching the A/B Reverb Toggle Switch to the A + B position will simultaneously run Reverbs A and B in parallel and mix them together (in stereo) to the Outputs. It is also possible to run the reverbs in series (Reverb A into Reverb B). To run the reverb engines in series, first flip the toggle switch to either the A or B Reverb, then hold down the CONTROL INPUT button (at the top of the pedal) and switch the toggle back to the A + B position – the reverbs now run in series. Follow the same process to switch back to parallel processing

Warning: If you connect the Neuro App cable from your mobile device to INPUT 2, the Ventris will detect it as an audio input and adopt one of the Stereo In Modes, which might create additional noise and affect the stereo signal. This is especially true when the Neuro App cable is not connected to the phone. You can override this action by going into the app and selecting the Mono In routing mode that you want. If you want to connect a stereo input AND the Neuro App cable into INPUT 2, use a TRS (Tip, Ring, Sleeve) stereo splitter and make sure that the Neuro signal is on the Ring and the instrument signal is on the Tip (the Sleeve acts as the ground).

Auto Routing Modes

There are four routing modes available when the Ventris is in its default Auto Detect mode. See detailed descriptions of each Auto Detect mode in the sections below.

- [Mono In, Mono Out \(1\)](#)
- [Stereo In, Mono Out \(2\)](#)
- [Mono In, Stereo Out \(3\)](#)
- [Stereo In, Dependent Stereo Out \(4\)](#)

Mono In, Mono Out (1)

This is the most common use case. Plugging the incoming signal into Input 1 with Output 1 connected to an amp (or the next device in the signal chain) produces a standard mono signal. Dual processing reverbs are also mixed down a single output.

Toggle = A

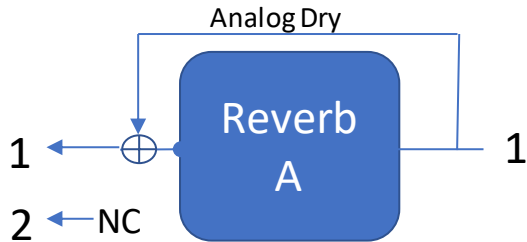

Toggle = B

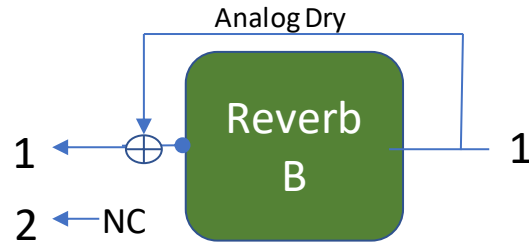

Toggle = A+B, Dual Parallel

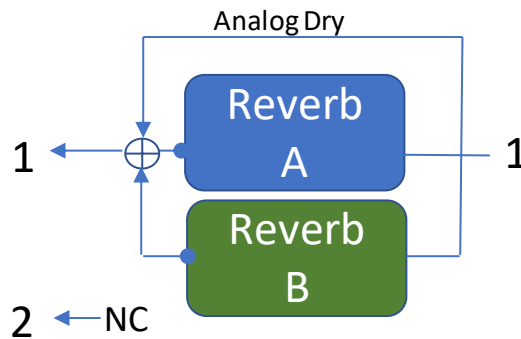

- **Mix Knob = Analog Dry Level**
- **Control 1 knob = Reverb A level**
- **Control 2 knob = Reverb B level**

Toggle = A+B, Dual Cascade

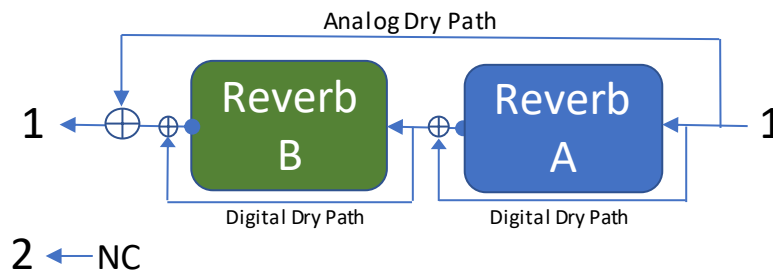

- **Mix Knob = Analog Dry Level**
- **Control 1 knob = Reverb A/Digital dry mix**
- **Control 2 knob = Reverb B/Digital dry mix**

Stereo In, Mono Out (2)

This mode receives two input signals and mixes them down to a single Output. It can be used for “sum to mono” applications. Note: there is NO INPUT 2 SIGNAL when the pedal is in bypass.

Toggle = A

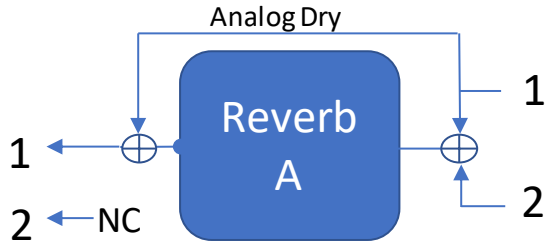

Toggle = B

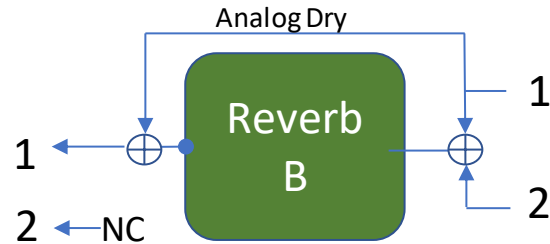

Toggle = A+B, Dual Parallel

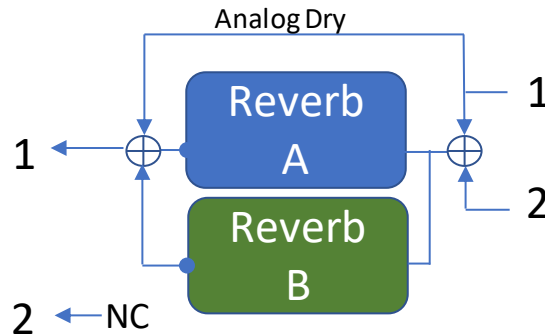

- **Mix Knob = Overall wet/analog dry mix**
- **Control 1 knob = Reverb A level**
- **Control 2 knob = Reverb B level**

Toggle = A+B, Dual Cascade

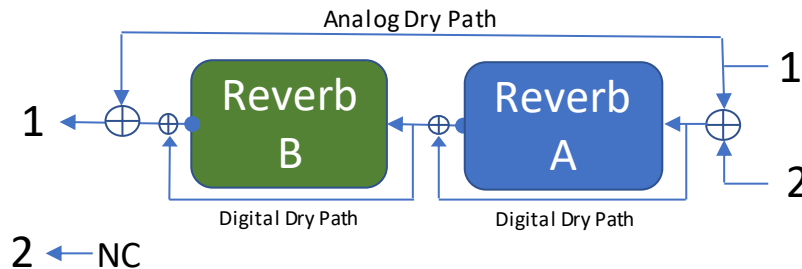

- **Mix Knob = Overall wet/Analog dry mix**
- **Control 1 knob = Reverb A/Digital dry mix**
- **Control 2 knob = Reverb B/Digital dry mix**

Mono In, Stereo Out (3)

This is a very common use case that allows you to create some nice stereo imaging from a single mono instrument input.

Toggle = A

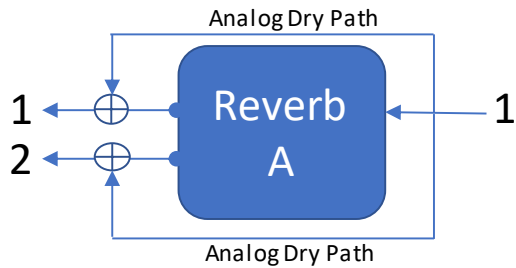

Toggle = B

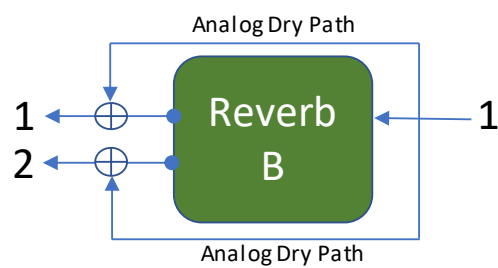

Toggle = A+B, Dual Parallel

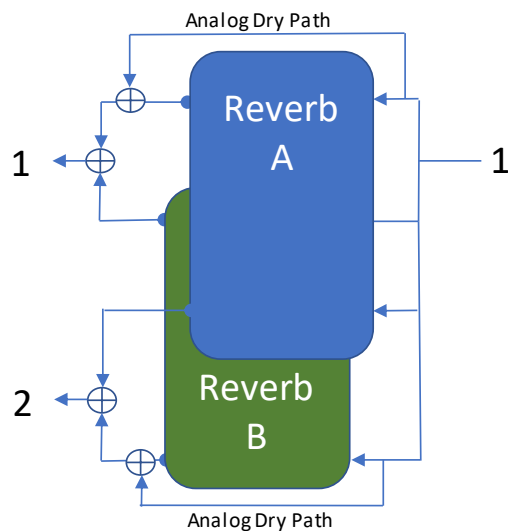

- **Mix Knob = Analog Dry Level**
- **Control1 knob = Reverb A level**
- **Control2 knob = Reverb B level**

Toggle = A+B, Dual Cascade

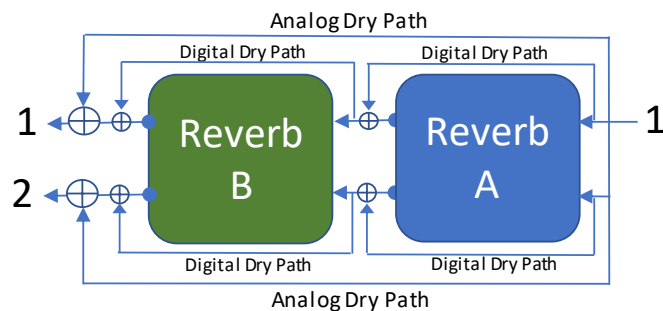

- **Mix Knob = Analog Dry Level**
- **Control1 knob = Reverb A/digital dry mix**
- **Control2 knob = Reverb B/digital dry mix**

Stereo In, Dependent Stereo Out (4)

This mode should be your default selection for Stereo In, Stereo Out applications. Most effective stereo reverb processing is performed with information from both input channels, so the modes in this section should not be considered as completely independent audio channels. If you are sure you want channel independence, seek the configurations with “independent” stereo signal processing.

Toggle Switch = Reverb A

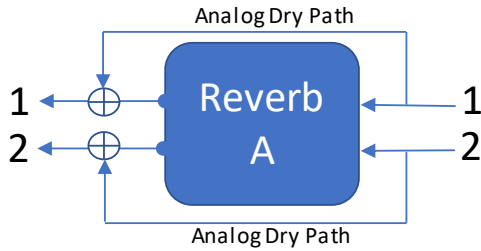

Toggle Switch = Reverb B

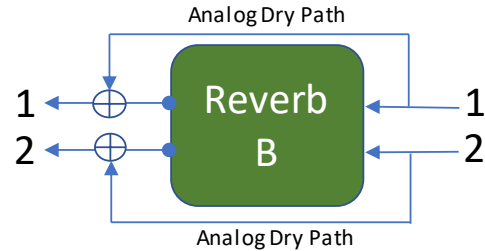

Toggle = Reverb A+B, Dual Parallel

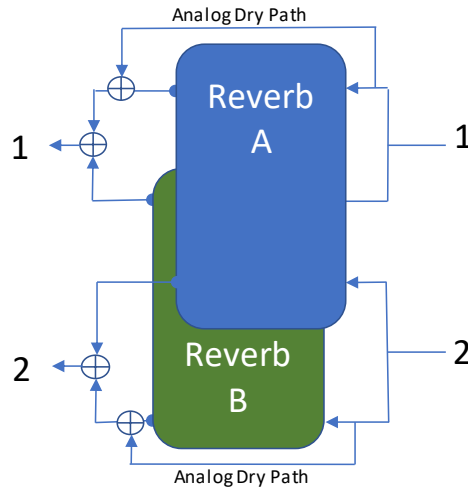

- **Mix Knob = Analog Dry Level**
- **Control 1 knob = Reverb A level**
- **Control 2 knob = Reverb B level**

Toggle = Reverb A+B, Dual Cascade

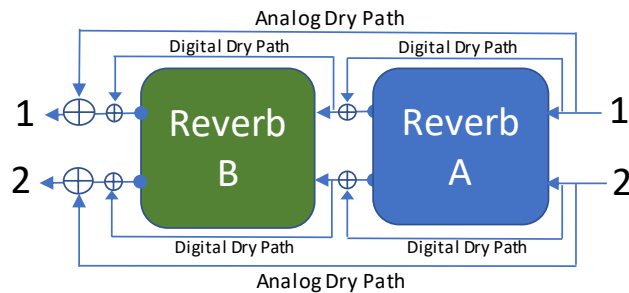

- **Mix Knob = Analog Dry Level**
- **Control 1 knob = Reverb A/digital dry mix**
- **Control 2 knob = Reverb B/digital dry mix**



Neuro Accessible Routing Modes

There are five additional Routing modes that are only accessible when the Ventris is connected to the Neuro Desktop Editor or the Neuro Mobile App. Each of these routing modes can be saved directly to any of the Ventris's User Preset positions. See the descriptions and signal graphs below for details.

- [Mono In, Mono Out, Dry Out 2 \(5\)](#)
- [Stereo In, Wet Sum to Mono \(6\)](#)
- [Dual Mono \(Independent Stereo\) \(7\)](#)
- [Mono In, Independent Stereo Out \(8\)](#)
- [Pre Processing External Loop \(9\)](#)

Mono In, Mono Out, Dry Out 2 (5)

This mode takes a mono signal through Input 1, sends a wet/dry mix through Output 1, and routes an additional dry signal to Output 2. This is great in a stereo rig when you want to apply reverb to one amplifier and a dry signal to a second amplifier.

Toggle Switch = Reverb A

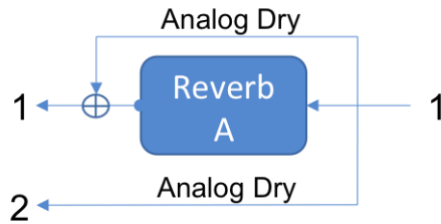

Toggle Switch = Reverb B

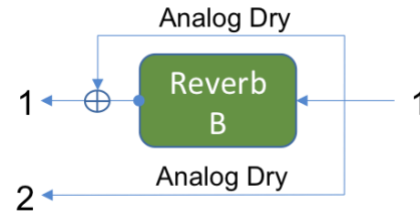

Toggle = Reverb A+B, Dual Parallel

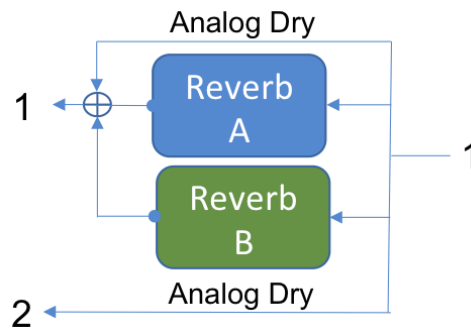

- **Mix Knob = Analog Dry Level**
- **Control 1 knob = Reverb A level**
- **Control 2 knob = Reverb B level**

Toggle = Reverb A+B, Dual Cascade

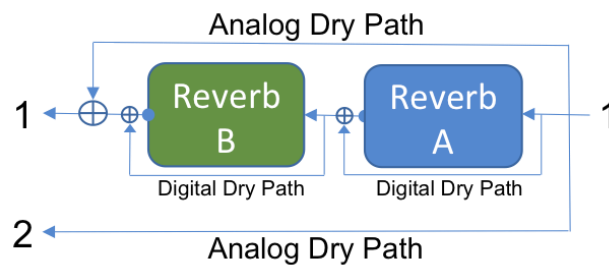

- **Mix Knob = Analog Dry Level**
- **Control 1 knob = Reverb A/Digital dry mix**
- **Control 2 knob = Reverb B/Digital dry mix**

Stereo In, Wet Sum to Mono (6)

Receives stereo input signals through Inputs 1 & 2, then sums the wet signal to mono through Output 1. The incoming dry signals maintain their stereo split with Output 1 receiving a wet/dry mix and Output 2 receiving only the dry signal. Note: the wet signal is affected by both dry signals from Inputs 1 & 2.

Toggle Switch = Reverb A

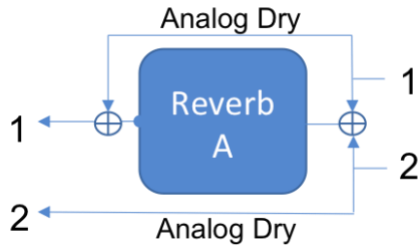

Toggle Switch = Reverb B

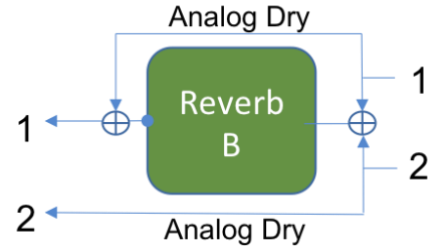

Toggle = Reverb A+B, Dual Parallel

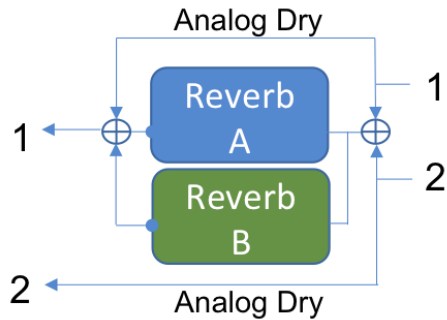

- **Mix Knob = Overall wet/analog dry mix**
- **Control 1 knob = Reverb A level**
- **Control 2 knob = Reverb B level**

Toggle = Reverb A+B, Dual Cascade

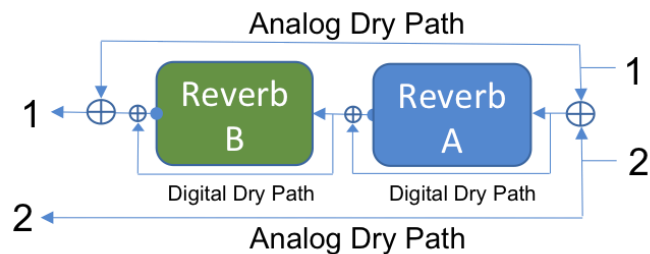

- **Mix Knob = Overall wet/Analog dry mix**
- **Control 1 knob = Reverb A/Digital dry mix**
- **Control 2 knob = Reverb B/Digital dry mix**

Dual Mono, (Independent Stereo) (7)

Functions just like two independent mono reverb pedals running in parallel. Input 1 is routed through Reverb A and mixes the wet and dry signals to Output 1. Input 2 is routed through Reverb B and mixes together the wet and dry signals to Output 2. Selecting position A or position B on the toggle switch will engage the selected Reverb while disengaging the non-selected Reverb. Select position A+B on the toggle switch to simultaneously engage both the A and B Reverbs (Note: this mode will not respond to Cascade routing).

Toggle Switch = Reverb A

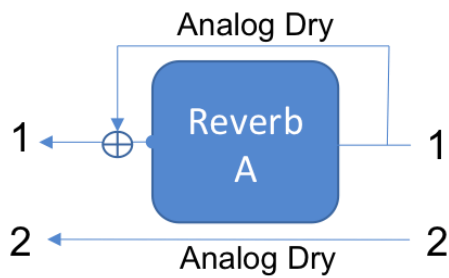

Toggle Switch = Reverb B

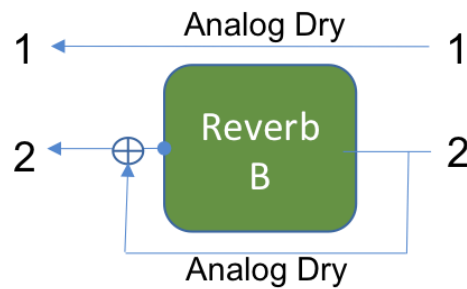

Toggle = Reverb A+B, Dual Parallel

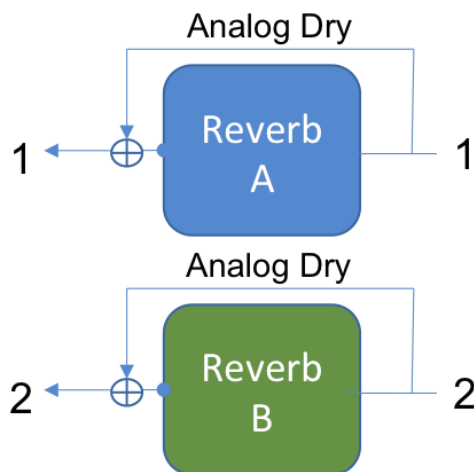

- **Mix Knob = Analog Dry Level**
- **Control 1 knob = Reverb A Level**
- **Control 2 knob = Reverb B Level**

Mono In, Independent Stereo Out (8)

Functions similar to Dual Mono, (Independent Stereo) mode, but responds only to the audio signal coming into Input 1 (Input 2 can still receive Neuro Mobile App information, but will not respond to incoming audio). Selecting position A or position B on the toggle switch will engage the selected Reverb while disengaging the non-selected Reverb (Note: the incoming dry mono signal will be split to both Outputs 1 & 2). Select position A+B on the toggle switch to simultaneously engage both the A and B Reverbs (Note: this mode will not respond in to Cascade routing).

Toggle Switch = Reverb A

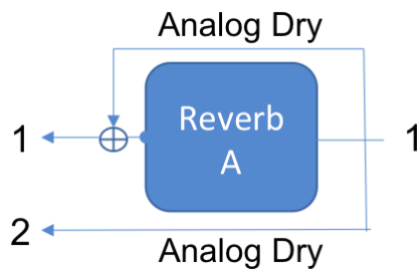

Toggle Switch = Reverb B

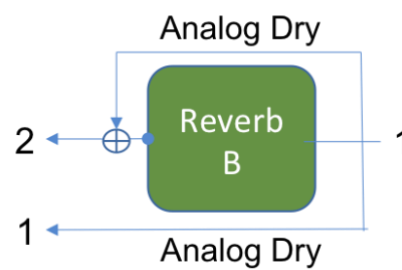

Toggle = Reverb A+B, Dual Parallel

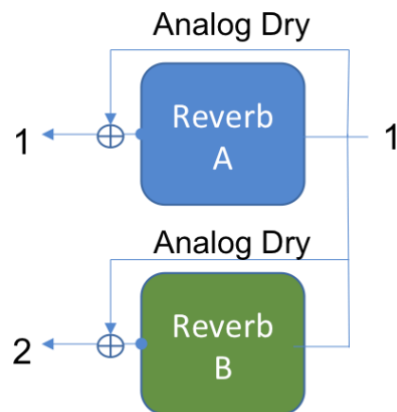

- Mix Knob = Analog Dry Level
- Control 1 knob = Reverb A Level
- Control 2 knob = Reverb B Level

Pre Processing External Loop (9)

Use this mode to insert an external effects pedal in series before the reverb engine. The external effect only becomes active when the Ventris is engaged. Connect the external effect pedal's input to Output 2 of the Ventris, and connect the external effects pedal's output to Input 2 of the Ventris. Selecting position A or position B on the toggle switch will engage the selected Reverb and disengage the non-selected Reverb. Select position A+B on the toggle switch to simultaneously engage both the A and B Reverbs

Warning – be careful when switching routing modes with an external loop configuration. If another routing mode is selected, an infinite feedback loop can be created accidentally. We recommend going into the [Neuro Hardware Settings](#) and selecting External Loop "Safe" Mode.

Toggle Switch = Reverb A

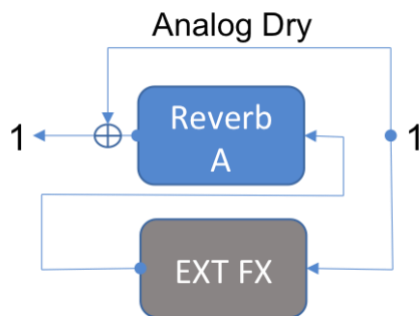

Toggle Switch = Reverb B

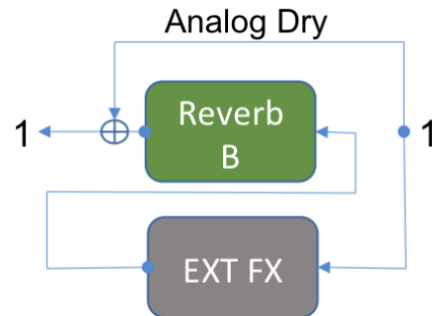

Toggle = Reverb A+B, Dual Parallel

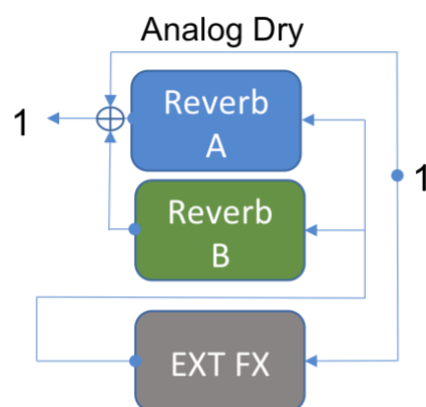

- **Mix Knob = Analog Dry Level**
- **Control 1 knob = Reverb A level**
- **Control 2 knob = Reverb B level**

Toggle = Reverb A+B, Dual Cascade

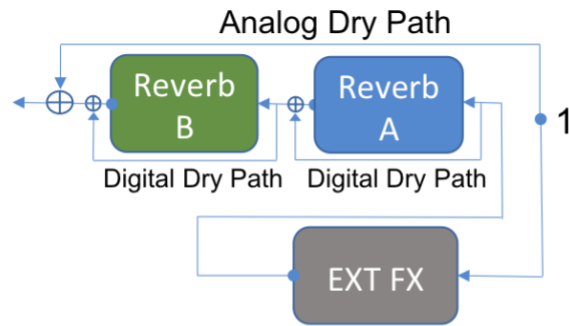

- **Mix Knob = Analog Dry Level**
- **Control 1 knob = Reverb A/Digital dry mix**
- **Control 2 knob = Reverb B/Digital dry mix**

External Loop Cable Connection Instructions

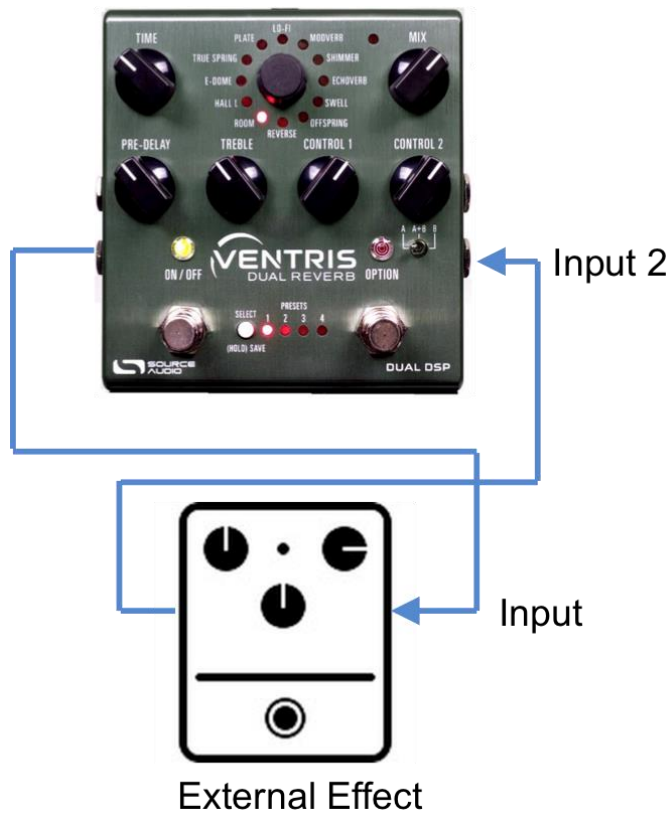

External Control

Plug an expression pedal, an external footswitch, the Source Audio Tap Tempo Switch, or the Source Audio Hot Hand 3 Universal Wireless Controller into the Ventris Dual Reverb's CONTROL INPUT or PEDAL IN jack and access an array of external functionality and expression control.



External Switches

External switches can be used for several different control options. They provide an easy way to remotely step through presets, input a tap tempo signal, and more. The Ventris is compatible with most passive single or dual external footswitches. The Ventris is also compatible with the Source Audio Tap Tempo Switch, which can be purchased directly from the Reverb.com [Official Source Audio Online Store](#). (Note: The Press and Hold (a.k.a. "Momentary") action is available to only the OPTION switch, it is not possible to assign this action to an external switch)

External Switches (1/4" TRS Connection)

Use an external switch to access an assortment of useful control options. Connect a passive single or dual footswitch to the 1/4" PEDAL IN jack on the top of the pedal and set the PEDAL IN switch (located next to the PEDAL IN jack) to the SWITCH setting. If using a single switch, connect using a regular mono (TS) cable. If using a dual switch use a stereo (TRS) cable. By default, the TIP signal is used to increment the current preset and the RING signal is used to decrement the current preset.



With the Neuro Desktop Editor, it is also possible to assign a number of different control functions to an external switch. Go to the Neuro Desktop [Hardware Options](#) section for instructions on assigning alternate control options to an external dual or single external switch.

External Switches (1/8" TRRS Connection)

The Source Audio Tap Tempo footswitch can also be connected to the CONTROL IN jack using a 3.5mm (1/8 inch) cable. If you wish to use this function, you must enable the function globally with the Use Control Input for External Switch option in the [Hardware Options](#) section of the Neuro Desktop Editor. You also need to use the Control Input dropdown menu to select the function of the Tap Tempo switch. Options include Preset Increment, Preset Decrement or Engine Tap Function (this option mimics whichever option has been selected (per preset) in the Option Tap dropdown menu of [Option Footswitch Assignment](#) section of the Sound Editor).

Source Audio Tap Tempo footswitches can be purchased directly from the Reverb.com [Official Source Audio Online Store](#).

External Expression Control

A variety of the Ventris's effects parameters can be controlled with a passive expression pedal connected to either the PEDAL IN or the CONTROL INPUT port. The expression pedal can be mapped to simultaneously control any combination of up to three knobs or Neuro parameters. Mapping parameters can be done either in the [External Control](#) section of the Neuro Desktop Editor or with the pedal by itself (see the [Configuring Expression Pedal](#) section for instructions on mapping knob parameters to an expression pedal without the Neuro Desktop).

External Expression Controller (1/4" TRS Connection – PEDAL IN jack)

Passive expression pedals such as the Source Audio Dual Expression Pedal or Reflex Universal Expression Pedal can be connected directly to the 1/4" PEDAL IN jack with a TRS cable. Make sure that the PEDAL IN switch (next to the PEDAL IN jack) is set to EXP when using this input for expression control. Third-party expression pedals can be used as well, as long as they have a TRS (Tip Ring Sleeve) plug with power on the ring, expression (the wiper of the potentiometer) on the tip, and ground on the sleeve, as seen in the diagram below.

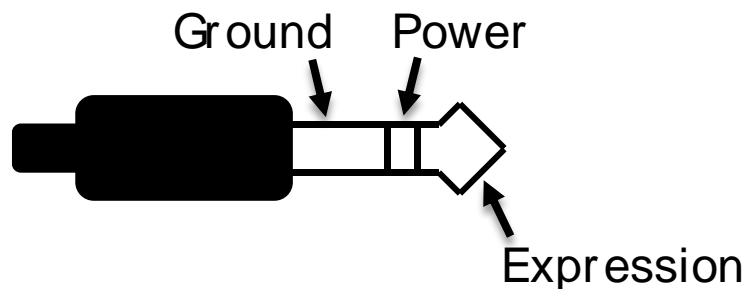

Please note, expression pedals with TS (Tip Sleeve) plugs will not work correctly with the expression input (PEDAL IN jack) of the Ventris. Also, the resistance of the expression pedal is not critical. Pedal calibration is done automatically when a new external control mapping is created.

External Expression Controller (1/8"/3.5mm TRRS Connection – CONTROL INPUT jack)

The Source Audio Dual Expression Pedal or Reflex Universal Expression Pedal can be directly connected to the CONTROL INPUT jack using a 3.5mm (1/8 inch), TRRS cable. In the case of an expression pedal with a TRRS plug, the tip connection is power, the first ring is the X-axis expression signal, the second ring is the Y-axis expression signal, and the sleeve connection is ground. In this configuration, the Ventriss uses the X expression signal as its expression source.

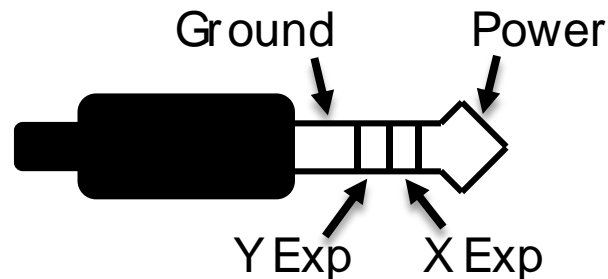

Third party expression pedals can be connected to the CONTROL INPUT as well, as long as they have a 3.5 mm (1/8") TRS (Tip Ring Sleeve) plug with power on the tip, expression (the wiper of the potentiometer) on the ring, and ground on the sleeve, as seen in the diagram below.

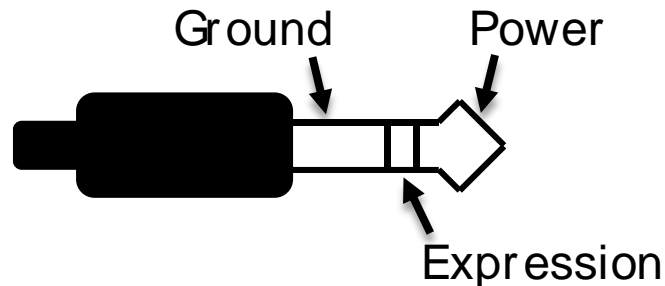

Expression pedals with TS (Tip Sleeve) plugs will not work correctly with the CONTROL INPUT of the Ventriss. For proper operation, the configuration steps in the next section must be followed when using any expression pedal, whether from a third party or from Source Audio.

Configuring the Expression Pedal

When the expression pedal is connected to the Ventriss, follow these simple steps to calibrate it and map it to control different effect parameters.

1. Press the CONTROL INPUT BUTTON to enable external control mode. The CONTROL LED should be lit red.
2. Press and hold the CONTROL INPUT BUTTON until the CONTROL LED begins to blink slowly (approximately one blink per second).
3. Move the expression pedal over the range of motion you would like to use to control the Ventriss. If you would like to use the expression pedal's full range of motion, make sure to move the pedal all the way from its minimum position to its maximum position. Note that

you can create “dead zones,” if desired, by only moving the expression pedal over a limited region of its full range of motion.

4. After setting the expression pedal range, click the ON/OFF FOOTSWITCH once. The calibration is now complete, and the CONTROL LED will blink faster (about 2 blinks per second). Now, it is time to map the expression pedal to the effect parameters.
5. Move the knobs and Neuro parameters (Neuro parameters only accessible when connected to the Neuro Mobile App or Neuro Desktop Editor) you wish to control with the expression pedal to the minimum desired position and then click the ON/OFF FOOTSWITCH. The CONTROL LED will now blink even faster (about 4 blinks per second). Note that you may control one or more knobs with the expression pedal, up to six total knobs.
6. Move the knobs and Neuro parameters you wish to control with the expression pedal to the maximum desired position and then click the ON/OFF FOOTSWITCH. The CONTROL LED will now be lit solid red.
7. After setting the minimum and maximum knob positions, the parameter mapping is complete.

Note: The parameter range can be inverted by swapping the minimum and maximum position of the knobs during steps 5 and 6.

Note: To cancel a control assignment, press the CONTROL INPUT button at any time during the process above.

Note: if you want to use the default Input Volume Control function but calibrate the range of an expression pedal, do the procedure above but cancel the assignment after step 4 by pressing the CONTROL INPUT button. The pedal calibration will be retained but no mapping to knobs will be created.

Once a mapping is created, it can be stored as part of a user preset. This way, each preset can be configured to have its own custom mapping.

External Control can be toggled on/off at any time by pressing the CONTROL INPUT button.

External Switch Used As Expression Input (Expression “Toggle”)

An external switch can also work as a sort of expression pedal that only has two positions: on and off. The external switch can be either momentary or latching.

External Switch as Expression Toggle (1/4” TRS Connection – PEDAL IN Jack)

To use this mode, connect an external switch to PEDAL IN and set the PEDAL IN switch to the EXP position instead of the SWITCH position. The following plug configuration is required:

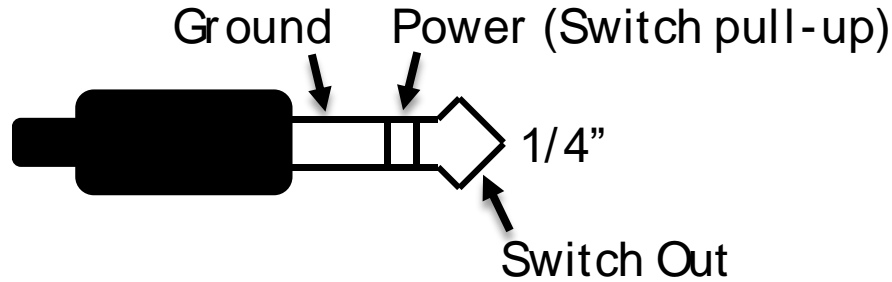

Follow these steps for configuration:

1. Press the CONTROL INPUT BUTTON to enable external control. The CONTROL LED should be lit red.
2. Press and hold the CONTROL INPUT BUTTON until the CONTROL LED begins to blink slowly (approximately one blink per second).
3. Tap the external switch once.
4. Click the ON/OFF FOOTSWITCH once. The CONTROL LED will blink faster (about 2 blinks per second). Now, it is time to map the external switch to the effect parameters.
5. Move the knobs and Neuro parameters (Neuro parameters are only accessible when connected to the Neuro Mobile App or Neuro Desktop Editor) you wish to control with the expression pedal to the minimum desired position and then click the ON/OFF FOOTSWITCH. The CONTROL LED will now blink even faster (about 4 blinks per second). Note that you may control one or more knobs with the expression pedal, up to six total knobs.
6. Move the knobs and Neuro parameters you wish to control with the expression pedal to the maximum desired position and then click the ON/OFF FOOTSWITCH. The CONTROL LED will now be lit solid red.
7. After setting the minimum and maximum knob positions, the parameter mapping is complete.

External Switch as Expression Toggle (1/8" (3.5mm) TRRS Connection – CONTROL INPUT Jack)

To use this mode, connect an external switch to CONTROL INPUT and set the PEDAL IN SWITCH to the SWITCH position instead of the EXP position. The following plug configuration is required:

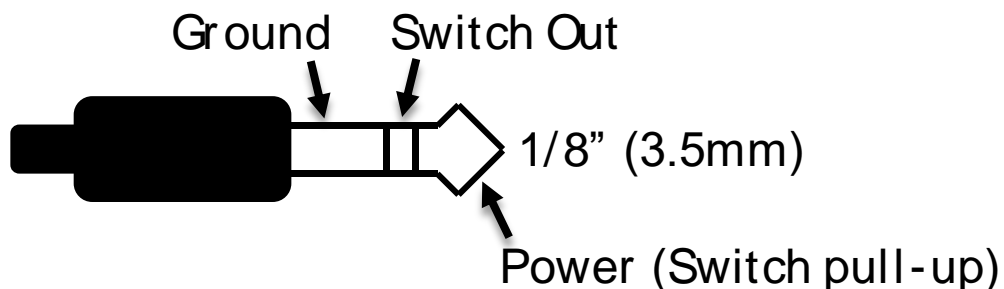

Follow these steps for configuration:

1. Press the CONTROL INPUT BUTTON to enable external control. The CONTROL LED should be lit red.

2. Press and hold the CONTROL INPUT BUTTON until the CONTROL LED begins to blink slowly (approximately one blink per second).
3. Tap the external switch once.
4. Click the ON/OFF FOOTSWITCH once. The CONTROL LED will blink faster (about 2 blinks per second). Now, it is time to map the external switch to the effect parameters.
5. Move the knobs and Neuro parameters (Neuro parameters are only accessible when connected to the Neuro Mobile App or Neuro Desktop Editor) you wish to control with the expression pedal to the minimum desired position and then click the ON/OFF FOOTSWITCH. The CONTROL LED will now blink even faster (about 4 blinks per second). Note that you may control one or more knobs with the expression pedal, up to six total knobs.
6. Move the knobs and Neuro parameters you wish to control with the expression pedal to the maximum desired position and then click the ON/OFF FOOTSWITCH. The CONTROL LED will now be lit solid red.
7. After setting the minimum and maximum knob positions, the parameter mapping is complete.

Hot Hand Input

The Hot Hand 3 Wireless Effects Controller can be connected directly to the CONTROL INPUT jack for wireless motion control of the Ventriss Reverb's effect parameters. The Hot Hand has two axes of expression: X and Y. These signals are carried on the two rings of the TRRS cable that comes from the Hot Hand receiver. The Ventriss uses the X expression signal.

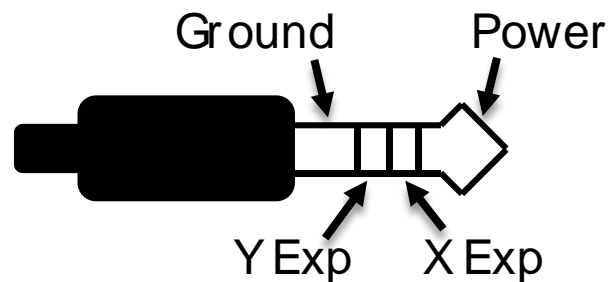

Configuring the Hot Hand

When the Hot Hand is connected to the Ventriss, follow these simple steps to calibrate it and map it to control different effect parameters.

1. Press the CONTROL INPUT BUTTON to enable external control. The CONTROL LED should be lit red.
2. Press and hold the CONTROL INPUT BUTTON until the CONTROL LED begins to blink slowly (approximately one blink per second).
3. Move the Hot Hand ring over the range of motion you would like to use to control the Ventriss. The easiest way to do this is to move the ring in the same way that you intend to move it as you perform. The Ventriss will intelligently select the X or Y axis of the Hot Hand automatically, based on the motion of the ring.
4. After setting Hot Hand range of motion, click the ON/OFF FOOTSWITCH once. The calibration is now complete, and the CONTROL LED will blink faster (about 2 blinks per second). Now, it is time to map the Hot Hand to the effect parameters.

5. Move the knobs and Neuro parameters (Neuro parameters are only accessible when connected to the Neuro Mobile App or Neuro Desktop Editor) you wish to control with the Hot Hand to their minimum desired position and then click the ON/OFF FOOTSWITCH. The CONTROL LED will now blink even faster (about 4 blinks per second). Note that you may control one or more knobs with the Hot Hand, up to four total knobs.
6. Move the knobs and Neuro parameters you wish to control with the Hot Hand to the maximum desired position and then click the ON/OFF FOOTSWITCH. The CONTROL LED will now be lit solid red.
7. After setting the minimum and maximum knob positions, the parameter mapping is complete.

Reset Expression Control Mapping

To clear the expression control mapping (Expression or Hot Hand), first press the CONTROL INPUT BUTTON to turn OFF control mode. The CONTROL LED should be off. Then, press and hold the CONTROL INPUT BUTTON until the CONTROL LED blinks 3 times. This clears all expression or Hot Hand mapping and resets external control back to the default Input Volume Control.

External Control Options Guide

For a quick reference guide to all of the Ventris's external control options, download the Ventris Dual Reverb Control Options Guide found at the bottom of the [Ventris Dual Reverb page](#) on the Source Audio website.



Neuro Desktop and Mobile Editors

Like all pedals in the Source Audio One Series line, the Ventriss Dual Reverb features an extensive collection of additional effects engines, deep editing parameters, and added functionality via the Neuro Desktop Editor and Mobile App. The Neuro Desktop Editor is currently available as a free download for Apple and Windows on the [Downloads](#) page of the Source Audio website. The updated Neuro Mobile App with Ventriss compatibility should be available in the spring of 2018.

The Neuro Desktop Editor

The Neuro Desktop Editor is an excellent tool for creating and organizing highly customized presets for your Ventriss Dual Reverb. The Desktop offers a set of additional reverb engines not included on the pedal's Effect Selector knob, an expanded collection of deep editing parameters, and an advanced cataloging system for naming and storing Ventriss presets. The Desktop is also a tool for installing the latest updates to your Ventriss Dual Reverb firmware.

Downloading and Connecting the Neuro Desktop Editor

The Neuro Desktop Editor is a free download for Mac and Windows PCs. To download the Neuro Desktop, go to [the Source Audio Downloads page](#). In the Software tab select the appropriate file (you have a choice between the Mac and Windows versions) and download it. You will also want to download the latest One Series Pedal Firmware, which is located directly below the Neuro downloads.

After the download process, connect your Ventriss Dual Reverb with a USB Type A male to mini Type B male cable (Warning: don't use a charger cable). Connect the cable from the mini USB port on the pedal to the USB port on your computer. Once you've made the connection a blue box will appear in the Connections field indicating that the Ventriss is ready to be edited.

If a new Ventriss firmware update is available, the Firmware Update icon (the arrow icon) will be framed in yellow. When you click the arrow icon, you will be instructed on the updating procedure. **(Note: It is important disconnect all other Source Audio pedals and turn off MIDI software during the firmware updating process.)**

Neuro Desktop Editor User Interface

The Neuro Desktop’s user interface features three primary sections: [Connections](#), [Sound Editor](#), and [Presets](#).

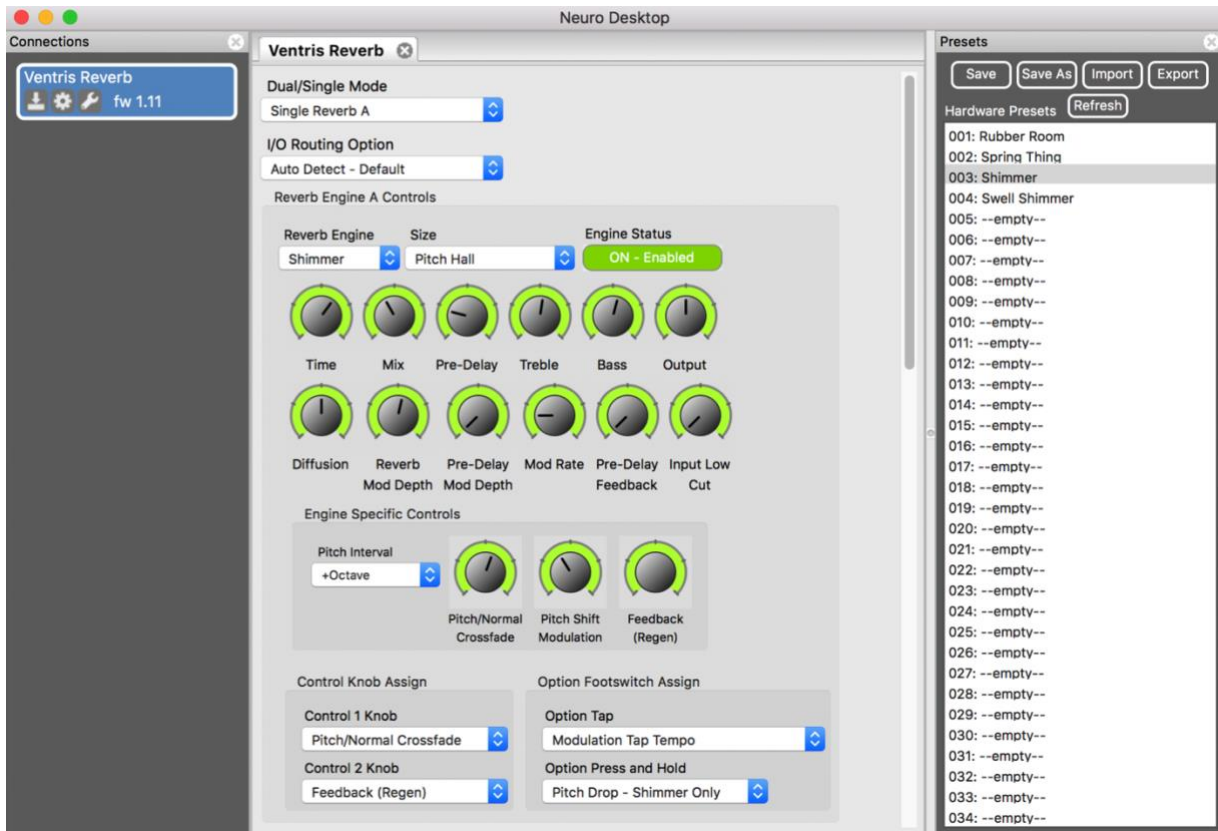

Connections

The Connections section is located on the left side of the Neuro Desktop Editor. This field displays all connected One Series pedals. Each connected pedal offers the three options listed below:

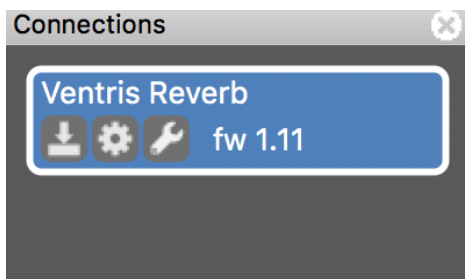

- Firmware Updates:** The arrow icon checks for any recent firmware updates to the connected pedal. If an update is available, the software will provide instructions on how to proceed.

- **Hardware Option:** The gear icon opens the Hardware Options window. Each Source Audio pedal has its own set of global hardware settings. The attached pedal will retain all hardware option edits until either the option is de-selected or a Factory Reset is performed.
- **Open Editing Interface:** The wrench icon opens the Ventris Dual Reverb’s Sound Editor, revealing a deep set of editing controls for creating custom presets.

Hardware Options

Clicking the gear icon in the Ventris Dual Reverb’s Connections window opens the Hardware Options menu (see the graphic below). Use the Hardware Options window to choose your pedal’s universal hardware settings.

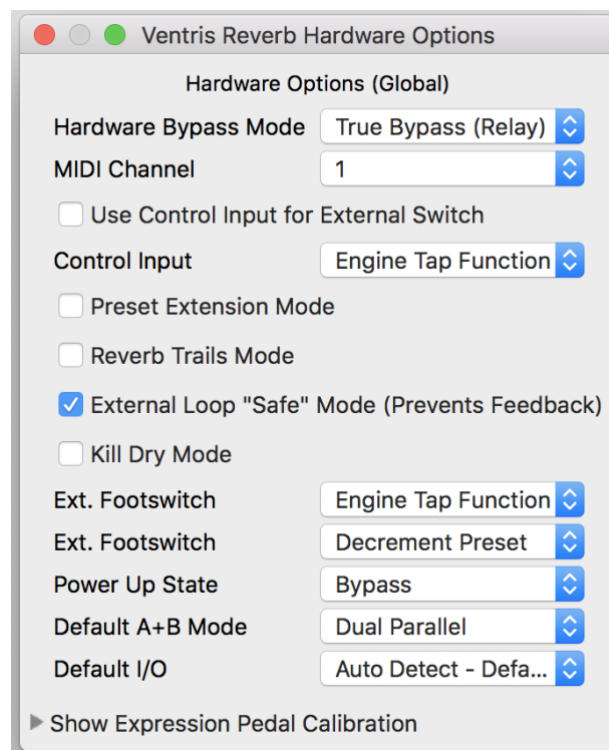

The Ventris Dual Reverb’s Hardware Options include the following:

- **Hardware Bypass Mode:** Selects between True or Buffered Bypass.
- **MIDI Channel:** Selects the pedal’s MIDI channel (1 through 16).
- **Use Control Input for External Switch:** Checking this box allows the Ventris to respond to an external switch plugged into the 1/8” CONTROL INPUT on the top of the pedal. **Note: The CONTROL INPUT only responds to the Source Audio Tap Tempo Switch and its TRRS plug. When using a 3rd part footswitch, we recommend using the ¼” PEDAL IN jack (with the PEDAL IN switch set to “SWITCH.”**
- **Control Input:** This dropdown menu assigns the control function of the external switch connected to the CONTROL INPUT. There are three choices: *Increment Preset*, *Decrement Preset*, and *Engine Tap Function*. Selecting the *Engine Tap Function* allows you to control

whichever option has been selected within the *Option Tap* dropdown menu in the SOUND EDITOR. **Note:** *Engine Tap Function* is a global setting. However, you can change the *Engine Tap Function's* assignment for each preset! To select the Tap assignment, you must go to the SOUND EDITOR in each preset and select from the list of option in the *Option Tap* dropdown menu. See below:

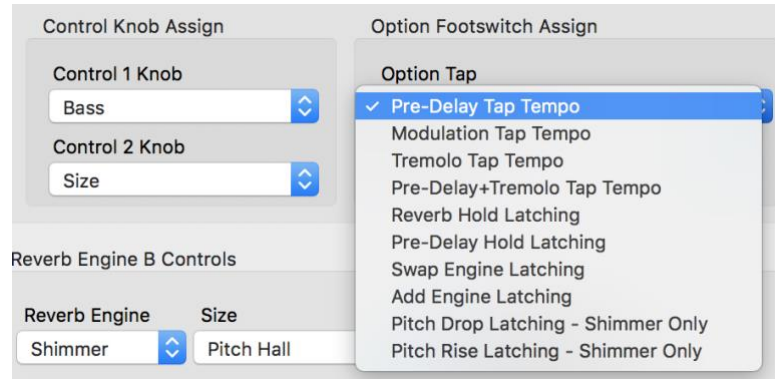

For a full explanation of each *Option Tap* function, go to the [Option Footswitch Assign](#) section of this manual. **Note:** The Ventriss will not respond to Option Press and Hold (a.k.a. “Momentary”) switch action from an external switch. All of the OPTION switch’s Hold functions are still available with an external switch, but only with tapping (a.k.a. “Latching”) footswitch action.

- **Preset Extension Mode:** Adds an additional 4 user presets for a total of 8 presets accessible without MIDI messages.
- **Reverb Trails Mode:** Checking this box allows your reverb trail to decay naturally upon bypassing the effect.
- **External Loop “Safe” Mode (Prevents Feedback):** Check this box when using the [Pre-Processing External Loop](#) routing option. It will prevent your effect from feeding back when engaged.
- **Kill Dry Mode:** Completely eliminates the dry signal from the pedal’s output. Kill Dry Mode is helpful when using the Ventriss in an effects send.
- **Ext. Footswitch:** Plug a standard ¼” TRS, one or two button external footswitch to the Ventriss’s PEDAL IN jack and externally change presets or perform OPTION footswitch control functions. These two dropdown menus select the control assignments for each button on a two-button switch (Use the top field when only when connected to a single button switch). There are three choices: Increment Preset, Decrement Preset, and Engine Tap Function. Selecting the Engine Tap Function allows you to control whichever option has been selected within the [Option Tap dropdown menu](#) in the Sound Editor. **Note:** The Ventriss will not respond to Option Press and Hold (a.k.a. “Momentary”) switch actions from external switches.
- **Power Up State:** Selects between engaging or bypassing the effect upon the initial power up of the pedal.
- **Default A+B Mode:** Selects between Parallel and Cascade (a.k.a. “Series”) as the default A+B Toggle Switch Mode.

- **Default I/O:** Sets the default I/O signal routing mode. Descriptions of the available routing modes are available in the [Stereo Operation & Signal Routing](#) section of this manual.
- **Pedal Input & Control Input Calibration (Accessible via the Show Expression Pedal Calibration dropdown controls):** In the vast majority of cases, it is not necessary to change any of these values. However, in rare cases certain expression pedals require a custom range. When using a non-standard expression pedal, check its user manual for the specific calibration range.

Sound Editor

Upon clicking the wrench icon in the Connections section, the Ventris Dual Reverb’s Sound Editor interface appears in a tab in the center field. This is where all of the sound editing work takes place.

The Sound Editor is broken into several sub-sections, each containing a unique variation of virtual knobs and dropdown menus. The following is a brief explanation of each Sound Editor sub-section.

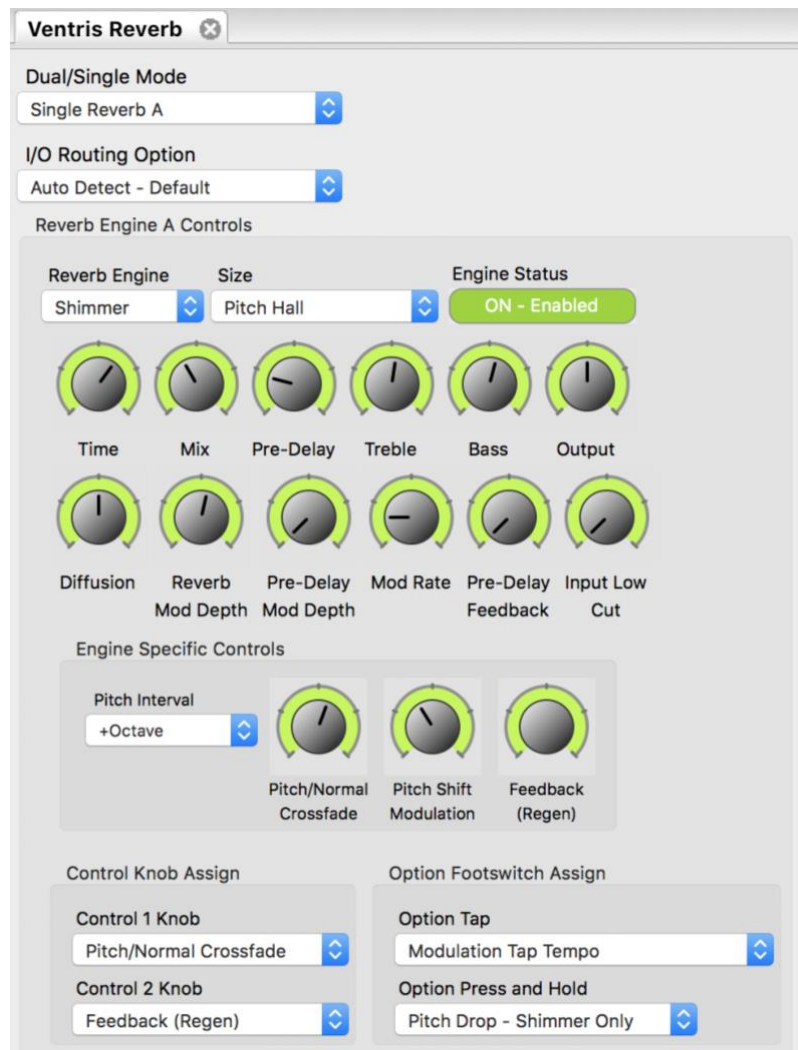

Dual/Single Mode

This dropdown menu essentially selects the virtual position of the A/B Toggle switch on the Ventriss Dual Reverb. Select whether you want to edit Reverb A, Reverb B, or Reverb A + B. In addition you can select between a Parallel or Cascade signal path for Reverb A + B.

I/O Routing Option

Select the routing configurations of Inputs and Outputs 1 & 2. See the [Stereo Operation & Signal Routing section](#) for a detailed explanation of each routing option.

Reverb Engine A Controls

This block contains a comprehensive collection of editing tools for Reverb A. The block is broken into the following sub-groups:

- **Reverb Engine:** Select the reverb engine for Reverb A. You will notice that in addition to the twelve engines available on the Ventriss Reverb's Effect Selector knob, there is an ever-growing collection of additional reverb engines. Go to the [Reverb Engines](#) and [Extended Reverb Engines](#) sections for a complete list and explanation of each available reverb type.
- **Size:** This dropdown menu offers a subset of root settings within each reverb engine. For example: within the Hall L engine there is a choice between five different Hall sizes: Normal, Medium, Large, Extra Large, and Enormo-Hall
- **Enable Status:** This field indicates whether Reverb A is enabled or disabled. The Dual/Single Mode dropdown menu selects the state of the Enable Status indicator and the virtual position of the A/B Toggle switch on the pedal.
- **Primary Engine Controls:** There are 12 primary control knobs for customizing each reverb preset. Among this set of virtual knobs are controls like TIME and PRE-DELAY, which are also found on the face of the Ventriss Dual Reverb. In addition, there are controls like DIFFUSION and OUTPUT, which are only accessible with the Neuro Desktop Editor.
- **Engine Specific Controls:** This set of virtual knobs and dropdown menus changes depending on selected reverb engine. For example the Modverb engine requires engine specific controls like TREMOLO DEPTH and RATE that do not apply to any of the other reverb engines.
- **Control Knob Assign:** By default the CONTROL 1 & 2 knobs on the Ventriss Dual Reverb are assigned to specific parameters depending on the selected reverb engine. But it is also possible to reassign the function of these two knobs within each preset. The Control Knob Assign dropdown menus offer a variety of additional, assignable parameters.

Option Footswitch Assign

Tapping or holding the Ventriss Dual Reverb's OPTION footswitch accesses specific default functions, depending on the selected reverb engine (see the [Reverb Engines section](#) for the default functions of each engine). In addition, it is possible to reassign these footswitch functions. The Option Footswitch Assign dropdown menus offer a variety of additional footswitch functions.

Option Tap Dropdown Menu Choices

All of the following functions are accessible by tapping the OPTION footswitch.

- **Pre-Delay Tap Tempo** – Use the Option footswitch as a tap tempo of set the time of the Pre-Delay. Similar to a delay pedal this allows you to create an echo effect by changing the time between the dry signal and the first reverb reflections. *Note: you must tap the switch more than two times in succession to change the Pre-Delay time.*
- **Modulation Tap Tempo** – Tap the Option footswitch to set the rate of the pitch modulation in the wet signal.
- **Tremolo Tap Tempo** – Tap the Option switch to set the time of the tremolo when using the Modverb Engine.
- **Pre-Delay + Tremolo Tap Tempo** – Simultaneously sets the speed of the tremolo pulse and the reverb Pre-Delay time of the Modverb engine.
- **Reverb Hold Latching** – Sustains the reverb trail with a single push and release of the Option switch. Tap the Option switch again to release the Reverb Hold function and let the reverb trail decay.
- **Pre-Delay Hold Latching** – Sustain the Pre-Delay with a single push and release of the Option switch. Tap the Option switch again to release the Pre-Delay Hold function
- **Swap Engine Latching** – Tap the Option switch and move from Reverb A to Reverb B. Tap again to go back to Reverb A.
- **Add Engine Latching** – Tap the Option switch to add Reverb B to Reverb A (A+B Mode). Tap again to return to only Reverb A.
- **Pitch Drop Latching – Shimmer Only** – While using the Shimmer engine, a single push and release of the Option switch sustains the reverb trail and engages the Pitch Drop function, creating a dive-bomb effect with the Shimmer’s pitch interval. Tap the Option switch again to release the Pitch Drop function and let the reverb trail decay.
- **Pitch Rise Latching – Shimmer Only** – While using the Shimmer engine, a single push and release of the Option switch sustains the reverb trail and engages the Pitch Rise function, creating gradual rise in the Shimmer engine’s pitch interval. Tap the Option switch again to release the Pitch Rise function and let the reverb trail decay.

Option Press and Hold Dropdown Menu Choices

All of the following functions are accessible by pressing and holding the OPTION footswitch. The Press and Hold action is also known as “Momentary Switch” action, which engages the assigned function only as long as the OPTION footswitch is held down. **(Note: The Press and Hold action is available to only the OPTION switch, it is not possible to assign this action to an external switch)**

- **Reverb Hold** – Sustains the reverb trail while holding down the Option switch. While sustaining the trail of Reverb A, Reverb B will be applied to the dry signal. This allows you to play a reverb effected lead line on top of Reverb A’s sustained trail.
- **Pre-Delay Hold** - Sustain the Pre-Delay.
- **Pre-Delay Build** – Sustains and recirculates the Pre-Delay creating an intensifying effect known as self-oscillation.

- **Pitch-Drop – Shimmer Only** – While using the Shimmer engine, holding down the Option switch sustains the reverb trail and engages the Pitch Drop function, creating a dive-bomb effect with the Shimmer’s pitch interval.
- **Pitch-Rise – Shimmer Only** – While using the Shimmer engine, holding down the Option switch sustains the reverb trail and engages Pitch-Rise function, creating gradual rise in the Shimmer engine’s pitch interval.
- **Swap Engine – Momentary** – Hold the Option switch and switch from Reverb A to Reverb B. Release the switch and go back to Reverb A.
- **Add Engine – Momentary** – Hold the Option switch to add Reverb B to Reverb A (A+B Mode). Release the switch to return to Reverb A alone.
- **Hold Other Engine** – Add and Hold the trail of Reverb B, while maintaining the undisturbed reflections of Reverb A. For details and diagrams on the Hold Other Engine function go to the [Reverb Hold Function](#) section.

Reverb Engine B Controls

Every control option available in the Reverb A block is mirrored in Reverb B block. See the Reverb Engine A Controls section for detailed explanations the Reverb Engine B Controls.

Dual Mode Controls

While running two reverb engines simultaneously in either Dual Parallel A + B or Dual Cascade A -> B Modes (see the Dual/Single Mode dropdown menu), it is useful to independently control the levels of Reverb A, Reverb B, and the dry signal. Use the Sound Editor’s Level A, Level B, and Analog Dry Level knobs to create an overall mix for all Reverb A+B presets.

This block also contains two dropdown menus for assigning Dual Mode functions to the OPTION footswitch. By default the OPTION footswitch will perform whatever function is assigned to Reverb A, but there are a number of alternate functions available in the dropdown menus.

Spillover Controls

One of the major advantages of the Ventris Dual Reverb’s dual processor architecture is the ability to adjust the spillover time when changing from one single engine preset to another. Rather than abruptly cutting off the reverb tail, spillover allows for a smooth and natural transition between presets by letting the initial reverb decay naturally. In the case of switching away from a preset with an extremely long decay time, it can be useful to shorten the final decay with an alternate Spillover Time. Use the Spillover Time dropdown menu to adjust the decay time, which can be set for up to 20 seconds. (Note: Spillover does not apply when changing to or from a Dual Reverb Mode (A+B).

Kill Reverb Send On Spillover – Click this box to stop the dry signal from going into the reverb preset you have exited during the spillover period. For example - imagine you are using a preset with an E-Dome reverb engine that has a very long trail, and you have set the Spillover Time for 15 seconds and

checked the Kill Reverb Send box. When you switch away from that E-Dome preset its reverb trail will start its decay and no longer respond to the incoming dry signal.

On/Off Status (MIDI Recall)

Use the dropdown menu to select whether a preset is engaged or disengaged upon receiving a MIDI program change (PC) message. Sometimes it is useful to queue-up a preset in a disengage state that is accessible by manually hitting the ON/OFF footswitch on the Ventris.

External Control

Control up to three parameters with an external expression pedal or a Hot Hand 3 Universal Wireless Expression Controller. Use the dropdown menus in the External Control block to select the expression device (Control Source) and controlled parameter (Control Option). Use the Min and Max fields to set the depth of the expression sweep.

Presets

The Presets section is located on the right side of the Neuro Desktop interface. There you will find a list of all the presets and empty preset positions available in your Ventris. The Presets section is also where you Save, Import, and Export presets. The buttons located at the top of the Presets field perform the functions listed below:

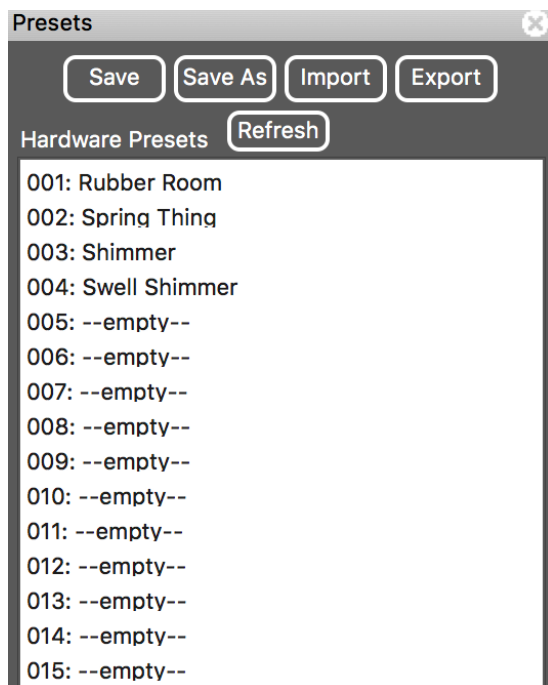

- **Save As Button:** After creating a new preset hit the Save As button and you will be prompted to name it and select the preset or Effect Selector position to which it will be saved.

- **Save Button:** If you have made edits to a pre-existing preset, use the Save button to update the preset without changing its name or preset position.
- **Export Button:** Use the Export button to save a preset on your computer or share it with other musician. Presets are saved as .pre files and stored anywhere on your computer (we recommend creating a dedicated folder to store your presets). After creating a preset, hit the Export button - a window will pop up, asking you to name, tag, and select a location for the preset. After the preset is saved, the .pre file can be shared via email or any common file sharing method.
- **Import Button:** Use the Import button to upload saved .pre files to your Neuro Desktop Editor. Upon clicking the Import button you will be asked to find the .pre file. Simply go to your Neuro presets folder, select file, and upload.
- **Refresh Button:** Hit the Refresh button to restore the Neuro Desktop edits to the state immediately after your last save procedure.
- **Hardware Presets:** This is where all of your pedal presets are listed. Use the Save As button to select where you would like to store an edited preset - you can choose from any of the 128 preset positions or the 12 Effect Selector knob positions on the Ventris Dual Reverb.

The Neuro Mobile App

Note: The Neuro Mobile App is not yet available for the Ventris Dual Reverb. The updated version will be available shortly. Please email contact@sourceaudio.net if you have any questions regarding the status of the Neuro Mobile App. This manual will be updated with full instructions after the update is complete.



Like all the pedals in the Source Audio One Series line, the Ventris Dual Reverb will feature an extensive collection of additional reverb engines, deep editing parameters and added functionality via the Neuro Desktop and Mobile Editor software. The Neuro Mobile App will be available for iOS and Android devices and the Neuro Desktop Editor will be available for Windows and Macintosh personal computers. All Neuro downloads are free.

Neuro Hub

The Source Audio Neuro Hub (sold separately) unites Source Audio pedals from the Soundblox 2 and One Series families to create a single, stage-ready effects system. It features shared MIDI, passive expression pedal input, Hot Hand connectivity, and USB, and can connect up to five Source Audio pedals. The Neuro Hub features a powerful scene saving functionality, which allows you to create up to 128 multi-pedal presets known as scenes, each recallable via MIDI program change messages. Connect the Neuro Hub to your computer via USB for updates, saving and editing multi-pedal presets, and more. To connect the Ventris to the Neuro hub, use a 3.5 mm TRRS cable and make a connection

between the Ventris's CONTROL INPUT jack and any of the Neuro Hub's multi-function outputs. For more information, refer to the Neuro Hub documentation on the Source Audio website.

MIDI

Using the MIDI IN jack (5-pin DIN) or a USB connection, the Ventris can be controlled by generic MIDI Continuous Controller (CC) and Program Change (PC) messages. Many of the Ventris's parameters (even those that are not assigned to a control knob) are directly accessible via MIDI continuous controller messages.

MIDI Channel

By default, the Ventris responds to MIDI Channel 1. The Ventris ignores all MIDI messages sent to it that are not on its channel. The input MIDI channel for the Ventris can be changed in the Hardware Options menu of the Neuro Editors. Note that the MIDI Input Channel is a **global** setting that is NOT saved per preset. Note that some manufacturers begin counting MIDI channels at zero (from 0 to 15), while the Source Audio Neuro Editors use the convention of counting from 1 to 16.

Selecting Presets via Program Change (PC) Messages

The 128 user presets on the Ventris can be recalled via program change messages. Presets 1 to 128 are mapped to MIDI Program Change messages 1 to 128.

It is possible to save presets with the Ventris bypassed. This means the preset can be recalled without actually engaging the reverb effect. The reverb effect can then be engaged either by pressing the ON/OFF FOOTSWITCH or by sending the proper MIDI Continuous Control message.

Many of the parameters in the Ventris can be controlled via MIDI. For more details, see [MIDI Implementation](#).

Controlling the Ventris with MIDI Continuous Controller (CC) Messages

The Ventris responds to MIDI Continuous Controller (CC) messages. The pedal comes already mapped to a default set CC numbers. For a complete list of default MIDI mappings and ranges, download the Ventris Dual Reverb MIDI Implementation Guide located at the bottom of the [Ventris Dual Reverb page](#) on the Source Audio website.

Custom CC Mapping

The default MIDI map provides control over parameters using specific Continuous Controller messages. It is also possible to override the default map and create custom mapping. Custom MIDI CC mappings are global, meaning they are not unique per preset. The CC mapping will apply in all situations, regardless of which preset is active.

To create a custom MIDI CC mapping, follow these steps:

- Connect your Ventris to the Neuro Desktop Editor.
- In the top bar menu select *Device* then *Edit Device MIDI Map* from the dropdown menu.

- The *Ventris Reverb MIDI Map Editor* window will open. Simply scroll to the MIDI CC value you wish to remap and click that CC's dropdown menu. A list of parameter choices will unfold.
- Select the parameter you wish to re-assign to the chosen CC. The process is complete.

USB

The Ventris's USB port is plug-and-play ready for Windows and Mac computers. The Ventris uses class-compliant drivers, so no special drivers are needed. Just power up the Ventris and connect it to the computer using a USB cable. The computer will automatically recognize the Ventris, which will be identified as "One Series Ventris Dual Reverb" in the operating system.

USB connectivity brings many benefits, such as the ability to connect with the Neuro Desktop Editor for downloading Ventris firmware updates, accessing an advanced set of effect editing parameters, and downloading alternate reverb engines. The USB port is also provides MIDI connectivity to audio production software.

USB-MIDI

The Ventris will appear as a MIDI device in your computer's operating system. As a result, the Ventris can communicate with audio production software that utilizes MIDI, such as Pro Tools, Ableton Live, Logic Pro, and more. MIDI messages can be sent directly to the Ventris using the USB connection, which allows for full automation of the Ventris within host software such as a DAW. For example, the depth or speed of the LFO can be automated by outputting MIDI continuous controller messages from the host software to the Ventris via the USB connection. For more details, see [MIDI Implementation](#).

Specifications

Dimensions

- Length: 11.63 cm (4.58 inches)
- Width: 11.17 cm (4.40 inches)
- Height (not including knobs and footswitches): 3.71 cm (1.46 inches)
- Height (including knobs and footswitches): 5.61 cm (2.21 inches)

Weight

- 450 grams (1 pound)

Power

- 280 mA @ 9V DC
- Center negative, Barrel positive plug, 2.1 mm inner diameter, 5.5 mm outer diameter

Audio Performance

- Maximum Input Level: +6.54 dBV = 8.76 dBu = 2.12 V RMS = 6.0 V p-p
- Full Scale Output Level: +6.54 dBV = 8.76 dBu = 2.12 V RMS = 6.0 V p-p
- Input Impedance: 1 Mega Ohm (1 M Ω)
- Output Impedance: 600 Ohm (600 Ω)
- 110 dB DNR Audio Path

- 24-bit Audio Conversion
- 56-bit Digital Data Path
- Universal Bypass (relay-based true bypass and analog buffered bypass)

Troubleshooting

Restore Factory Settings

In order to revert the Ventris to its factory settings, clearing all user data, presets, expression mappings and custom effect engines, use either the Neuro Mobile App or Neuro Desktop Editor and choose the Factory Reset option in the Hardware Options menus. It is also possible to perform a factory reset without the Neuro App by following these steps:

- Press and hold the OPTION FOOTSWITCH.
- Connect the power supply.
- The CONTROL LED will blink rapidly until the reset is complete. You can stop holding the TAP FOOTSWITCH once the CONTROL LED starts to blink.

Noise

Power source: Ensure that the proper power supply is being used.

Near noise source: Move pedal away from power supplies and other equipment.

Other equipment: Remove other effects from signal chain; see if noise persists.

Bad cables: Swap out audio cables.

USB ground loop: When connected to a computer using a USB cable, noise can appear in the audio signal. This usually results from ground loop noise due to the Ventris and computer running on separate power supplies. In the case of laptops, disconnecting the computer's power supply and running it on a battery can often mitigate the noise. External display monitors are often the primary source of noise, and powering down monitors can also resolve noise issues.

Ground loop with amp: Make sure your Ventris is running on the same power mains circuit as your guitar amplifier.

Hot Hand Doesn't Work

Low power: Ensure that the proper power supply is being used.

Not calibrated properly: Calibrate the Hot Hand. See the [Hot Hand Input](#) section for more details.

Not connected properly: Check Hot Hand connections.

Unit Appears Dead / No LEDs Lit

Wrong power supply: Use correct power supply. See the [DC 9V \(Power\)](#) section for more details.

Frequently Asked Questions

How can I access the extended reverb engines without the app?

The extended reverb engines can be accessed via MIDI or USB-MIDI. Send a MIDI message CC #1 with a value between 0 and 23. Values 0 to 11 correspond to engines Room (0) through Reverse (11). Values 12 to 23 correspond to extended engines.

What kind of instruments can I connect to the Ventris's inputs?

The Ventris's audio inputs are high impedance (~ 1 MΩ) and they can accept high impedance signal sources like guitars/basses with passive pickups, as well as low impedance sources like line-level audio circuits, guitars/basses with active pickups, electronic keyboards, or mixer outputs. The input circuit can handle signals ranging up to 6.0 Volts, peak-to-peak.

Can I power the Ventris directly over USB, without using the 9 Volt supply?

No. USB provides 5 Volts, but the Ventris needs 9 Volts, so the Ventris cannot be powered directly from USB. Make sure that you have plugged in the included 9V DC power supply when connecting to the Ventris's USB port.

When connecting the Ventris to a recording interface or mixer, should I use a Lo-Z (microphone) or Hi-Z (line / instrument) input?

The Ventris's output will be low impedance when the effect is active or in buffered bypass mode, but it will be high impedance when using true bypass mode and a guitar with passive pickups. Therefore, it is recommended that you use a high impedance (Hi-Z) input on your recording interface or mixer to avoid signal loss.

Why doesn't the Ventris respond to MIDI messages being sent to it?

By default, the Ventris should respond to MIDI continuous controller messages on channel 1. The Ventris's MIDI channel can be configured using the Neuro Editors. Channel numbers in MIDI use zero-based counting, so MIDI channel 1 is described as 0 in hexadecimal, MIDI channel 2 is described as 1 in hexadecimal, and so on, concluding with MIDI channel 16, which is described as F in hexadecimal. A continuous controller message starts with a hexadecimal B and is followed by the channel number (0 through F).

So, the command byte from your MIDI controller should be formatted as shown in the following table:

MIDI Channel (Decimal)	1	2	3	4	5	6	7	8	9	10	11	12	13	14	15	16
CC Command Byte (Hex)	B0	B1	B2	B3	B4	B5	B6	B7	B8	B9	BA	BB	BC	BD	BE	BF

Each continuous controller command byte is followed by two bytes, the CC number and the value. So, each CC message consists of a total of three bytes. If the Ventris is not responding to MIDI, make sure that your MIDI controller is properly configured and sending messages in the format described above.

Can I use the Ventriss in my amp’s effects loop?

The Ventriss’s audio inputs can handle up to 8.76 dBu or 6.0 Volts peak-to-peak, which allows it to work in most amp effects loops. Be sure to check your amp’s documentation to verify that the maximum send level is less than the Ventriss’s maximum input level.

How do I update the firmware?

Firmware updates are available via the Neuro Desktop Editor using the USB port. Power the pedal and connect it to your computer using a mini USB cable. The Neuro Desktop Editor is available from Source Audio’s website: <http://www.sourceaudio.net/support/downloads>. While the pedal is connected, select the Arrow Icon located in the Ventriss Dual Reverb square in the Connections field.

Mac Gatekeeper

Mac users may see this warning message when trying to open the updater software: “App can’t be opened because it was not downloaded from the Mac App Store.” In order to run the updater, please refer to the steps in this Apple support article: <https://support.apple.com/en-us/HT202491>.

Rubber Feet

The Ventriss comes standard with a flat aluminum bottom, making it easy to apply Velcro and mount to a pedalboard. Additionally, adhesive rubber feet are included in the Ventriss box. Applying the rubber feet to the Ventriss can help prevent it from sliding on flat surfaces such as a hardwood floor.

Waste Disposal Notes



If possible, dispose of the device at an electronics recycling center. Do not dispose of the device with the household waste.

For full compliance with EN 61000-4-6 standard, input cable must be less than 3 meters in length.

Warranty

Limited Transferrable Warranty

Source Audio, LLC (hereinafter “Source Audio”) warrants that your new Source Audio One Series Ventriss Dual Reverb, when purchased at an authorized Source Audio dealer in the United States of America (“USA”), shall be free from defects in materials and workmanship under normal use for a period of two (2) years from the date of purchase by the original purchaser. Please contact your dealer for information on warranty and service outside of the USA.

Under this Limited Warranty, Source Audio’s sole obligation and the purchaser’s sole remedy shall be repair, replacement, or upgrade, at Source Audio’s sole discretion, of any product that, if properly used and maintained, proves to be defective upon inspection by Source Audio. Source Audio reserves the right to update any unit returned for repair and to change or improve the design of the product at any time without notice. Source Audio reserves the right to use reconditioned parts and assemblies as warranty replacements for authorized repairs. Any product repaired, replaced, or

upgraded pursuant to this Limited Warranty will be warranted for the remainder of the original warranty period.

This Limited Warranty is extended to the original retail purchaser. This Limited Warranty can be transferred to anyone who may subsequently purchase this product provided that such transfer is made within the applicable warranty period and Source Audio is provided with all of the following information: (i) all warranty registration information (as set forth on the registration card) for the new owner, (ii) proof of the transfer, within thirty (30) days of the transfer, and (iii) a photocopy of the original sales receipt. Warranty coverage shall be determined by Source Audio in its sole discretion. This is your sole warranty. Source Audio does not authorize any third party, including any dealer or sales representatives, to assume any liability on behalf of Source Audio or to make any warranty on behalf of Source Audio.

Warranty Information

Source Audio may, at its option, require proof of the original purchase date in the form of a dated copy of the original authorized dealer's invoice or sales receipt. Service and repairs of Source Audio products are to be performed only at the Source Audio factory or a Source Audio authorized service center. Prior to service or repair under this Limited Warranty, the purchaser must request from Source Audio a return authorization, which is available at:

Source Audio LLC
120 Cummings Park, Woburn, MA 01801
(781) 932-8080 or at www.sourceaudio.net

Unauthorized service, repair, or modification will void this Limited Warranty.

Disclaimer and Limitation of Warranty

Do not open the effects pedal under any circumstance. This will void the warranty.

The foregoing limited warranty is the only warranty given by Source Audio and is in lieu of all other warranties. All implied warranties, including warranties of merchantability and fitness for any particular purpose, exceeding the specific provisions of this limited warranty, are hereby disclaimed and excluded from this limited warranty. Upon expiration of the applicable express warranty period, Source Audio shall have no further warranty obligation of any kind, express or implied. Source Audio shall in no event be liable for any special, incidental, or consequential damages suffered by the purchaser or any third party, including without limitation, damages for loss of profits or business or damages resulting from use or performance of the product, whether in contract or in tort. Source Audio shall not be liable for any expenses, claims, or suits arising out of or relating to any of the foregoing. Some states do not allow the exclusion or limitation of implied warranties so some of the above limitations and exclusions may not apply to you. This Limited Warranty gives you specific legal rights, and you may also have other rights, which vary, from state to state. This Limited Warranty only applies to products sold and used in the USA. Source Audio shall not be liable for damages or loss resulting from the negligent or intentional acts of the shipper or its contracted affiliates. You should contact the shipper for proper claims procedures in the event of damage or loss resulting from shipment.

Version History

March 15, 2018: Added Neuro Desktop Editor Instructions / Outboard Spring and Metal Box reverb engine descriptions / Link to MIDI Implementation Guide / Link to External Control Options Guide

October 12, 2017: Initial Release



©Source Audio LLC | 120 Cummings Park, Woburn, MA 01801 | www.sourceaudio.net