

Lunar Phaser User's Guide



Welcome

Thank you for purchasing the Lunar Phaser. This powerful stereo effects pedal features a collection of meticulously crafted phaser sounds ranging from 60s vibe sounds to quad-stage 80s shredder solos and modern sounds that explore new experimental sonic territory. With a simple control set, the Lunar can work in a wide variety of musical settings, and the powerful MIDI and Neuro control options under the hood provide access to a vast array of additional tonal possibilities.

The Lunar is housed in a durable, lightweight aluminum housing, packing rack mount power and flexibility into a compact, easy-to-use stompbox.

The USB and Neuro ports transform the Lunar from a simple phaser pedal into a powerful multi-effects unit. Using the free Neuro App (iOS and Android), a wide range of additional control parameters and effect types (chorus, flanger, resonator) are accessible. When used together with the Neuro Hub, the Lunar is fully MIDI-controllable and 128 multi-pedal presets, or “scenes,” can be saved for instant recall on the stage or in the studio. The Lunar can also connect directly to a passive expression pedal or the Hot Hand for expressive control of any parameter.

The [Quick Start](#) guide will help you with the basics. For more in-depth information about the Lunar Phaser, move on to the following sections, starting with [Connections](#).

Enjoy!

- The Source Audio Team

Overview

Diverse Phaser Sounds – Choose from traditional phaser tones such as Vibe, Classic, and Multi, or delve deeper into unique sounds cooked up in the Source Audio lab.

Flexible Stereo Routing – The Lunar is equally at home in a mono rig or a stereo rig. A variety of routing modes such as True Stereo, Mono, Mono-to-Stereo, Sum-to-Mono and External Loop allow the Lunar to harness the true power of stereo signal chains.

Compact Design – The durable, anodized aluminum housing has a slim profile, a small footprint, and sturdy hardware that will withstand the rigors of the road.

Universal Bypass™ – True bypass or buffered bypass? The choice is yours. The Lunar features high-quality signal relays for true bypass and transparent buffers for analog bypass.

Preset Saving – Save your favorite sound by pressing and holding the footswitch. No need to remember knob positions in the middle of a show.

Neuro Technology – The Neuro App opens up new possibilities for the Lunar, including completely new effect types, additional control parameters, and access to the Neuro Community, including free presets from artists and other users. The Neuro Hub can store up to 128 presets for the Lunar, easily recalled with a MIDI controller. You can also download any effects for the Gemini Chorus or Mercury Flanger and use them on the Lunar Phaser.

Deep Control Set – Beyond the four knobs on the face of the Lunar are many additional parameters. The Neuro App provides access to the inner workings of the phaser effect for advanced users who want to create a unique signature sound.

Parametric EQ and Low Cut – A 4-band parametric EQ is included in the Lunar, allowing for fine tonal control, and a low cut filter tightens up the low end.

MIDI Control – All of the Lunar’s parameters can be accessed and controlled using MIDI via the Neuro Hub or USB. Class compliant USB-MIDI allows the Lunar to work as a plug-and-play device with recording software running on Mac and Windows, and the MIDI Learn feature makes control mapping simple. The Lunar can also sync to your DAW or other MIDI devices using MIDI clock.

Quick Start

Power

To power the unit, connect the included 9V DC power supply to the jack labeled **DC 9V** on the back panel.

Warning: Using a non-Source Audio supply, especially an unregulated supply, could damage the unit. Please be very cautious when using 3rd-party power supplies.

Guitar/Audio Connections

Using standard ¼" mono cables, connect your guitar, bass, or other instrument to the INPUT 1 jack and your amp (or the next audio device in the signal chain) to the OUTPUT 1 jack.

When the power and audio connections have been made, the Lunar is ready to play.



Brief Knob, Footswitch, and Button Descriptions

Depth Knob: Controls the depth of the Low Frequency Oscillator (LFO), which determines the strength or prominence of the phaser effect.

Speed Knob: Controls the frequency of the LFO, which determines the speed of the phaser effect.

Resonance Knob: Controls the resonance of the effect by feeding the output back into the input – higher resonance could be described as “intense,” “brighter” or “chime-like.”

Shape Knob: Sets the shape of the LFO – choose between Sine, Square, Sawtooth, and more.

Effect Switch: Selects between the three basic phaser effect types – Vibe, Classic, and Multi.

Footswitch: Enables or bypasses the phaser effect. The large LED will be lit green when the phaser effect is engaged.

Contents

| | |
|---------------------------------|----|
| Welcome..... | 1 |
| Overview..... | 2 |
| Quick Start | 3 |
| Connections | 5 |
| Basic Phaser Operation..... | 9 |
| Effect Types..... | 11 |
| Controls..... | 12 |
| Preset Storage and Recall | 14 |
| Universal Bypass™ | 15 |
| Stereo Routing | 15 |
| Parametric EQ..... | 16 |
| External Control..... | 18 |
| Neuro App..... | 21 |
| Specifications | 31 |
| Troubleshooting..... | 32 |
| Frequently Asked Questions..... | 33 |
| Rubber Feet | 35 |
| Waste Disposal Notes | 35 |
| Warranty..... | 36 |
| Version History | 37 |

Connections

Input Side Connections



Input 1

This is the primary input for guitar, bass, or other instruments. It can also accept line-level inputs. Connect it to your instrument or other audio source using a mono (TS) ¼" cable.

Input 2

Input 2 can act either as an audio input or as the data connection for the Neuro App, or both at the same time.

Input 2 as an Audio Input

The tip contact on Input 2 acts as a secondary input for guitar, bass, or other instruments. It is only active when the Lunar is configured with a signal routing that uses stereo inputs. Connect it to your instrument (or the previous effect in the signal chain) using a mono (TS) ¼" cable. By default, the Lunar will auto-detect the routing mode. Other routing options are available using the Neuro App. For more information about stereo routing, refer to the [Stereo Routing](#) section.

Input 2 as a Neuro App Data Input

The ring contact on Input 2 acts as a data connection for the Neuro App. Connect it to your mobile device using a stereo (TRS) ¼" cable. It can also accept daisy-chained Neuro data from another Neuro-compatible pedal in the chain, provided that a TRS cable is used. The audio signal (if applicable) will be on the tip contact of the plug, and the Neuro App data will be on the ring contact.

Input 2 only accepts data from the Neuro App. Data from the Neuro Hub comes from the Control Input port.

Output Side Connections



Output 1

This is the primary output. Connect it to your amplifier, recording interface, or the next device in your effects signal chain using a mono (TS) 1/4" cable.

Output 2

Output 2 can act either as an audio output or as the daisy-chain data connection for the Neuro App, or both.

Output 2 as an Audio Output

The tip contact on Output 2 acts as the secondary audio output. It carries an audio signal when the Lunar is configured with a signal routing that uses stereo outputs. Connect it to your amplifier, recording interface, or the next device in your effects signal chain using a mono (TS) 1/4" cable.

Output 2 as a Neuro App Data Daisy-Chain Output

The ring contact on Output 2 acts as a data connection for the Neuro App, passing data from the Lunar to the next Source Audio effect in your signal chain. You can daisy-chain the Neuro App data regardless of whether Output 2 is configured to output audio or not. Connect Output 2 to the next device's Neuro App Data input (usually Input 2) using a stereo (TRS) 1/4" cable. The audio signal (if applicable) will be on the tip contact of the plug, and the Neuro App data will be on the ring contact.

Example Neuro Daisy-Chain Connections

Mono Audio Path with Neuro Daisy-Chain

In the case of a purely mono audio signal path, the Neuro data can be input to the first effect directly from the mobile device and then carried on to the second effect via TRS cable.



Mono-To-Stereo Audio Path with Neuro Daisy-Chain

In the case of a signal path that splits a mono input to stereo outputs, the Neuro data can be input to the first effect directly from the mobile device and then carried on to the second effect via TRS cable. The audio signal is carried on the same cable.

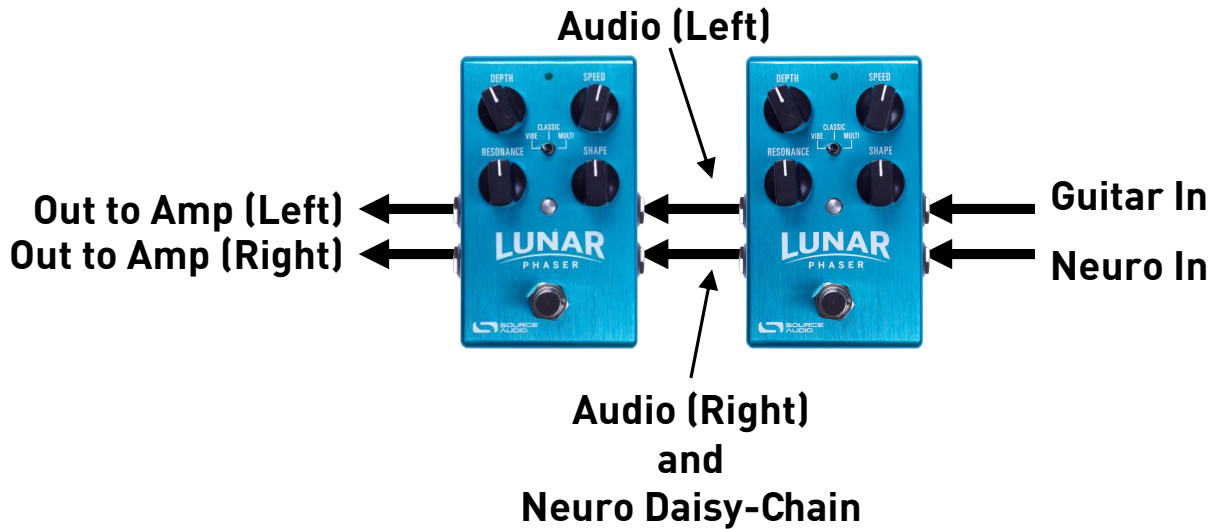

Power and Control Connections



DC 9V (Power)

Connect to the included 9 Volt DC power supply. The power supply must be regulated at 9 Volts (direct current), able to source at least 180 mA (milliamps) of current, and the plug should have a tip-negative, sleeve-positive polarity (the center tip is ground and the sleeve is power).

USB

Connect to your computer (Mac or Windows) to the Lunar's USB port (denoted by the  icon) using a standard mini USB cable. The Lunar is a class compliant USB device, meaning that it should be recognized by Mac and Windows computers automatically. For more information about the Lunar's USB capabilities, refer to the [USB](#) section of the User's Guide.

Control Input

The 3.5 mm Control Input port connects to external control devices such as the Dual Expression Pedal, Reflex Universal Expression Pedal, Neuro Hub, and Hot Hand Motion Controller. For more information, refer to the [Expression Pedal Input](#), [Hot Hand Input](#), and [Neuro Hub](#) sections of the User's Guide.

Basic Phaser Operation

A phaser, or phase shifter, is an effect that was originally designed to reproduce the sound of a “Leslie” rotating speaker cabinet. The phaser effect can be produced by several methods, the most common of which involves a network of all-pass filters, which introduce phase shifts into the input signal. When the phase-shifted signal is mixed with the original input, audible interferences are created, creating notches. If the phase shift amount is modulated over time, the notches sweep back and forth across the frequency spectrum, creating the phasing effect.

In technical terms, a phaser sweeps non-uniformly spaced notch filters through the frequency spectrum of an input signal.

The amount of phase shift in the phaser effect needs to be changed over in order to sweep the notch filters across the spectrum. In order to do this, a low frequency oscillator (also known as an LFO) is used to control the phase shift, as well as several other parameters. This is illustrated by the following graph:

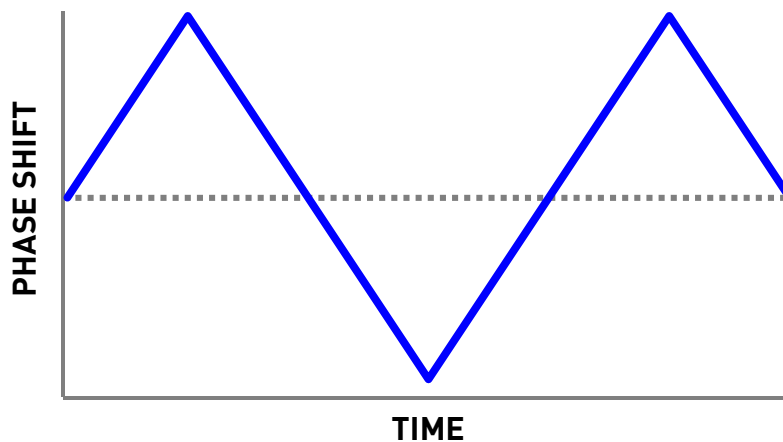

The blue line in the graph is known as the LFO. It changes the phase shift over time.

The frequency (a.k.a. “rate” or “speed”) of the LFO can be increased to get a more rapid change in the phase shift, as shown in this graph:

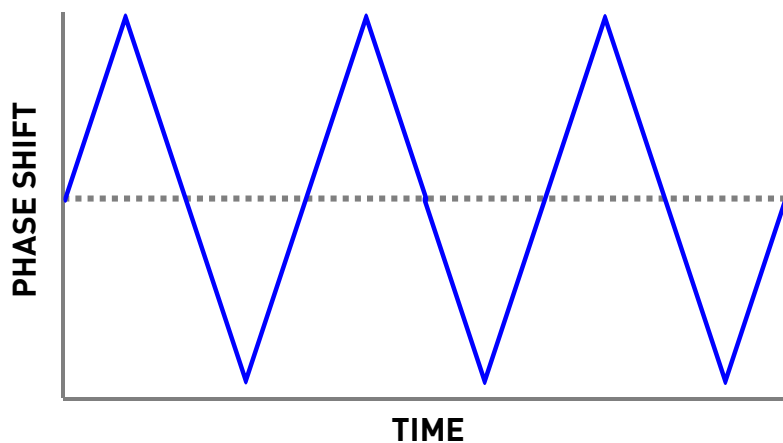

The depth of the LFO can also be changed to make the phaser effect more or less prominent, as shown in this graph:

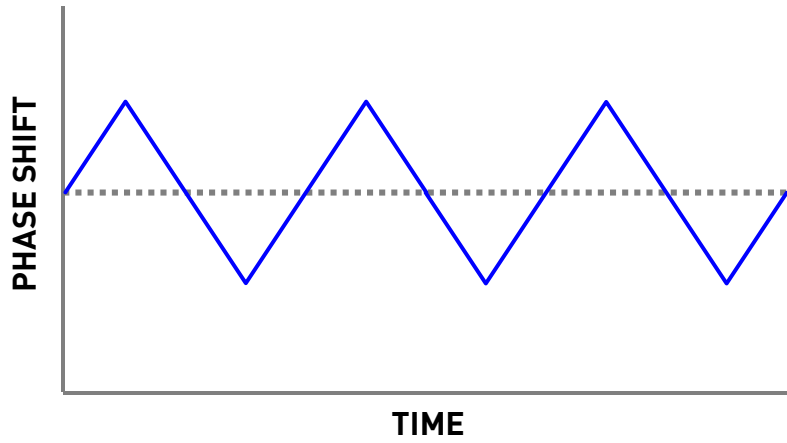

Finally, the shape of the LFO can be changed to give the phaser effect a different character.

Sine wave:

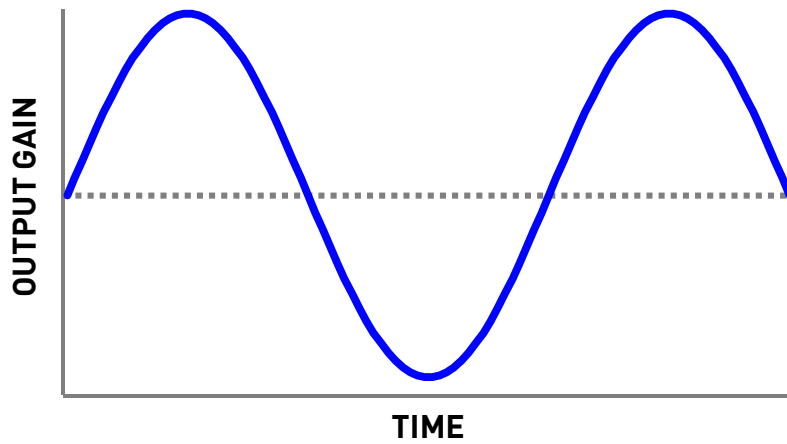

Square wave:

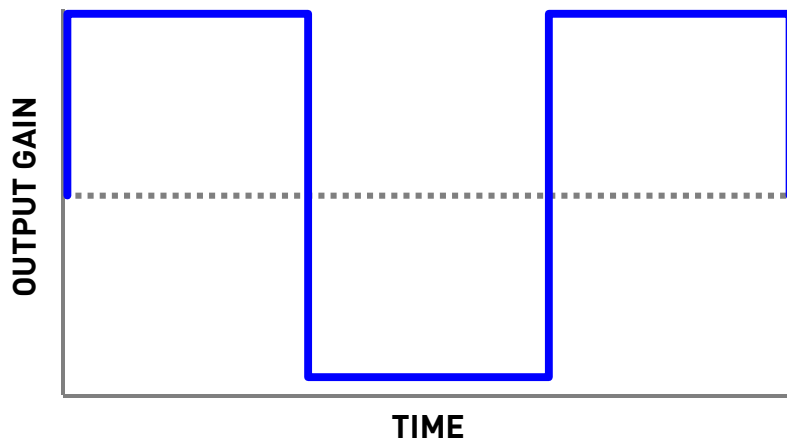

Effect Types

The Lunar includes three basic effect types, with more effects available in the Neuro mobile app.

Vibe

The Vibe Phaser effect was modeled after the Shin-Ei Univibe, the original rotating speaker simulator (i.e. the original phaser pedal). This effect contains 2 relatively wide frequency notches spaced farther from one another than a typical phaser.

Classic

The Classic Phaser effect is based on the same idea as the classic Phase 90, which uses 4 stages of phase shifters to create two relatively closely-spaced notches in the spectrum. This is the “chewy” phaser sound that has become nearly ubiquitous in rock and funk music, and feels right at home on guitars, basses, keyboards and electric pianos.

Multi

As a rule, every pair of phase shift stages creates one notch in the frequency response, so the Multi Phaser effect, which has 8 stages, creates 4 notches. This abundance of notches creates a more animated phaser effect when compared to the Classic and Vibe settings.

Additional Effect Types

Additional effect types can be loaded into the Lunar using the Neuro App on your mobile device (iOS and Android).

The Lunar Phaser is compatible with Source Audio’s Chorus and Flanger effects, so it is possible to load chorus, phaser, and flanger effects on the Lunar at the same time.

Controls



Knobs

Depth Knob

Controls the depth of the LFO, which determines how prominent the phaser effect is. When the depth is set fully counter-clockwise, the phaser effect will be most subtle. When the depth is set fully clockwise, the phaser effect will be most prominent.

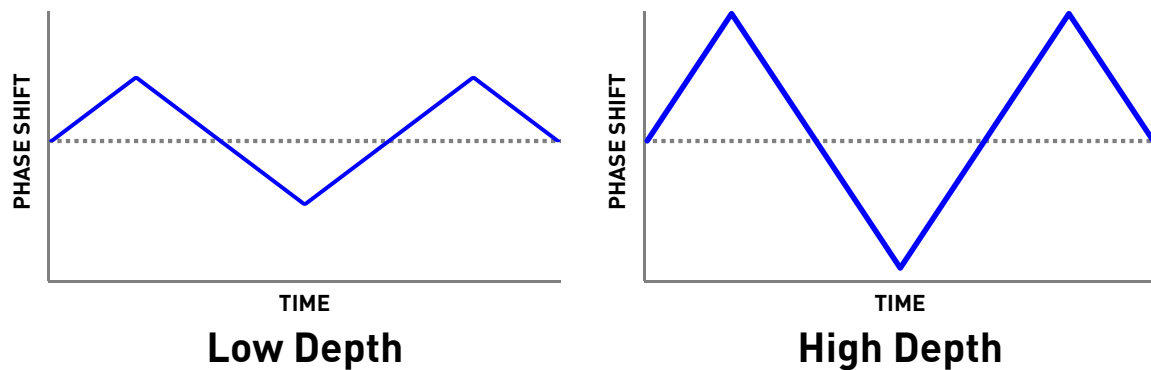

Speed Knob

Controls the frequency of the LFO, which determines how fast the phaser effect is. The minimum setting is 1 Hz (one LFO cycle per second) and the maximum setting is 10 Hz (ten LFO cycles per second).

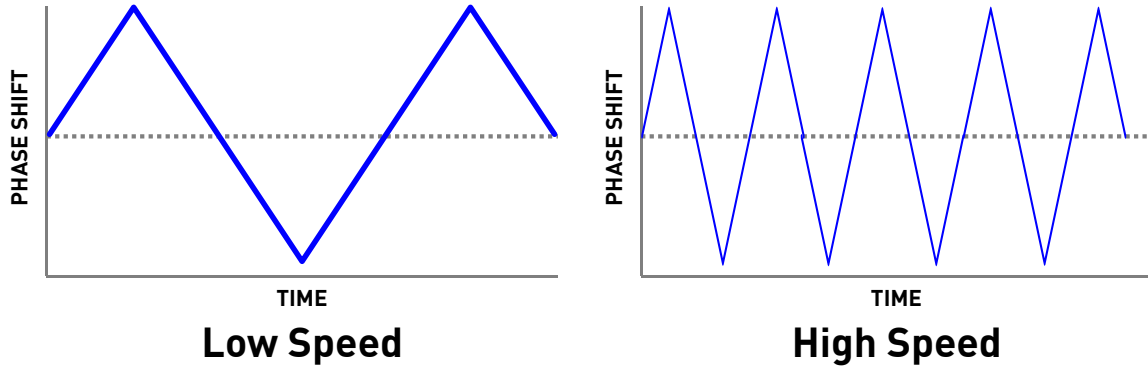

Resonance Knob

Sets the resonance of the notch filters in the phaser effect. Subjectively, a higher resonance will result in a more metallic, bell-like or chime-like sound, whereas a lower resonance will sound more subdued.

Shape Knob

Sets the shape of the LFO. For most effect types, Sine and Square shapes are available. In the minimum position, the LFO is typically a sine wave shape. Fully clockwise is a square shape. By dialing the Shape Knob somewhere between two different wave shapes, the LFO shape will be a hybrid shape, blending elements of both of those wave shape types.

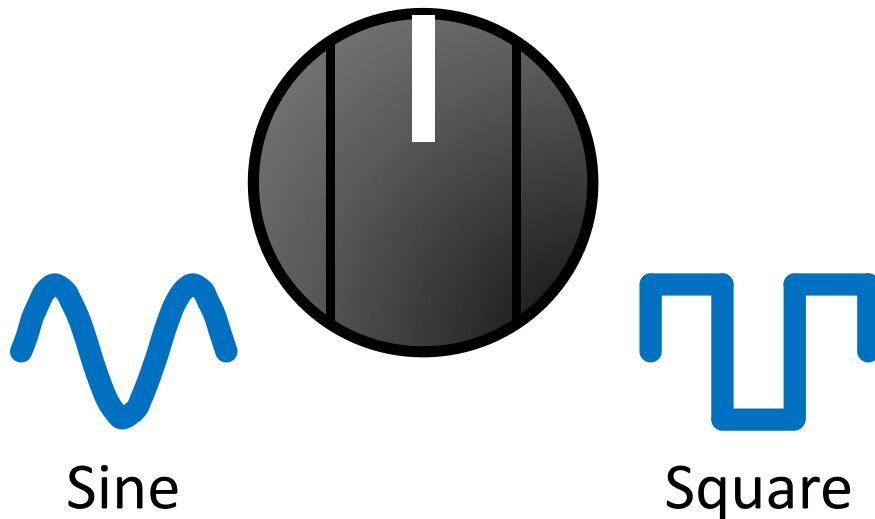

The Neuro App provide access to extended effect shapes, including envelopes.

Effect Switch

Selects between the three basic phaser effect types – Vibe, Classic, or Multi. These effects are described in further detail in the [Effect Types](#) section.

LEDs

Engage / Bypass LED

The Engage / Bypass LED above the footswitch indicates if the phaser effect is active (lit green) or bypassed (not lit).

When the user preset mode is enabled, the LED will turn red. See the [Preset Storage and Recall](#) section for more information about user presets.

External Control LED

The small LED located between the Depth and Speed knobs is the External Control LED. When lit, it indicates that external control mode (expression, hot hand, or MIDI) is active. For more information, see the [External Control](#) section.

Footswitch

Enables or bypasses the phaser effect.

Control Input Button

This small button is used when configuring external control. See the [External Control](#) section for more details.

Preset Storage and Recall

The Lunar features a user preset that can be easily saved and recalled using the footswitch. When a preset is recalled, all of the parameters instantly jump to their saved value, regardless of the position of the knobs. This allows you to save your favorite sound without having to worry about the knob positions.

Saving Your First Preset

- Bypass the Lunar by clicking the footswitch once. The engage/bypass LED should be dark at this time.
- Press and hold the footswitch for 5 seconds and wait for the engage/bypass LED to turn red. You are now in preset mode.
- Set up the effect how you want it to sound, including the effect switch, depth, speed, resonance, and shape knobs. Once you have made a change, the engage/bypass LED will begin to blink.
- To save your preset, hold the footswitch until the LED blinks rapidly 3 times.
- Now you can engage and bypass the Lunar using the footswitch, and each time you engage the effect, your saved preset will be recalled.

Editing a Preset

- Activate your preset (the engage/bypass LED will be solid red).

- Change any parameter you wish (effect switch, depth, speed, shape, and level knobs). Once you have made a change, the engage/bypass LED will begin to blink.
- When you are ready to save, press and hold the footswitch for a few seconds. The LED will blink three times to show that the preset was saved.

Exiting Preset Mode

- When Preset Mode is active, bypass the effect using the engage/bypass footswitch. The engage/bypass LED should be dark at this time.
- Press and hold the footswitch for 5 seconds and wait for the engage/bypass LED to turn off. You have now exited Preset Mode.

Quick Preset Switching

Using the Neuro App, it is possible to configure an option that speeds up the process of switching to/from preset mode. In this mode, preset mode activates in 800 ms instead of 5 seconds.

Universal Bypass™

Most effect pedals offer either true bypass or buffered bypass. The Lunar contains two separate circuits for bypass mode, allowing you to choose the method you prefer. The true bypass path uses signal relays, which are electromechanical switches. This provides an ultra-low resistance path from the input jacks to the output jacks, which is effectively the same as a wire. The buffered bypass path uses extremely low noise buffers, which provide a very low output impedance and are effective for driving long cables or long chains of effects following the Lunar's audio output.

Out of the box, the Lunar operates in true bypass mode. In order to switch to buffered bypass mode, edit the Lunar's global settings using the Neuro App.

We recommend you choose between the active analog bypass (a.k.a. buffered bypass) and relay-based true bypass based on what is needed in your signal chain. Ideally, the first pedal in a signal chain is a buffered input followed by true bypass in the rest of the signal chain.

Both bypass methods have pros and cons associated with them. Buffered bypass provides consistent input impedance so that if the source is susceptible to variations in input impedance (similar to a guitar pickup), there won't be a noticeable change in tone. True bypass has the benefit of providing a dedicated hardwired bypass signal path. The Lunar features small-signal relays for true bypass switching that offer reduced pops and clicks compared to the traditional true bypass switching method using a mechanical switch.

Stereo Routing

The Lunar works great as a mono phaser effect, but its stereo inputs and outputs also make it a true stereo effect as well as a flexible signal router. It can act as a stereo splitter, merger, or true stereo effect, and it can also be set up in a number of other unique signal routing modes.

By default (as of firmware version 1.06), the hardware will automatically set the routing mode by detecting cables connected to the inputs and outputs. If, for example, cables are connected to INPUT 1 and OUTPUT 1 only, then the routing mode will be set to Mono In, Mono Out. If cables are connected to INPUT 1, OUTPUT 1, and OUTPUT 2, then the routing mode will be set to Mono In, Stereo

Out. If cables are connected to INPUT 1, INPUT 2, OUTPUT 1, and OUTPUT 2, then the routing mode will be set to stereo in, stereo out. Other routing options are available via MIDI or the Neuro App.

A few different routing options are displayed below. The right side of each diagram shows inputs 1 and 2, the left side shows outputs 1 and 2, and phaser effects A and B are in the center.

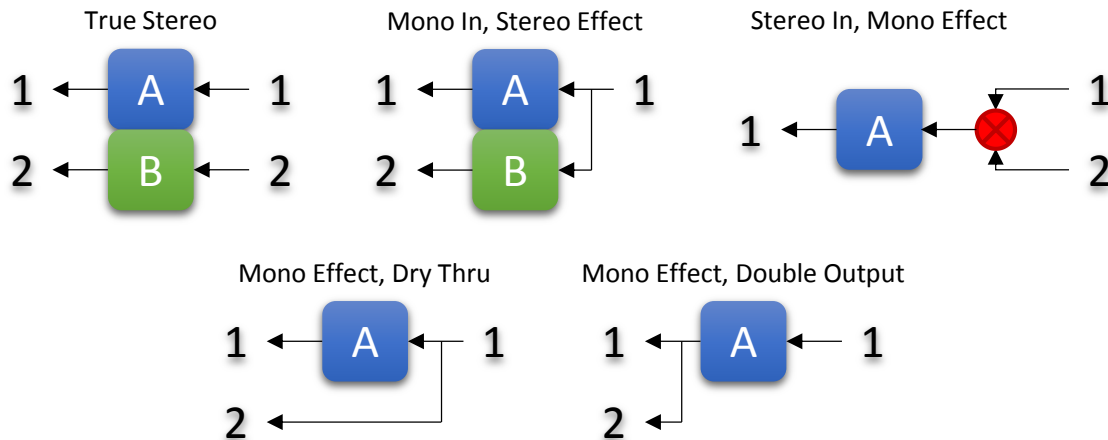

Parametric EQ

The Lunar features a built-in 4 band parametric EQ that can be configured using the Neuro App. Different EQ settings can be saved for each of the three effect types, as well as for the user preset.

The EQ consists of four independently configurable bands:

- **Band 1:** Low Shelf
- **Band 2:** Peaking (a.k.a. Bell / Band)
- **Band 3:** Peaking (a.k.a. Bell / Band)
- **Band 4:** High Shelf

Each band has configurable frequency, boost/cut, and Q (bandwidth).

A simple example of these four bands in action is shown in the graph below. In this example, Band 1 is a low shelf filter at 100 Hz with a 6 dB cut, Band 2 is a peaking filter at 620 Hz with a 3 dB cut and relatively high Q, Band 3 is a peaking filter at 3 kHz with a 1.5 dB boost and relatively low Q, and Band 4 is a high shelf filter at 10 kHz with a 2.5 dB cut.

Parametric Equalizer

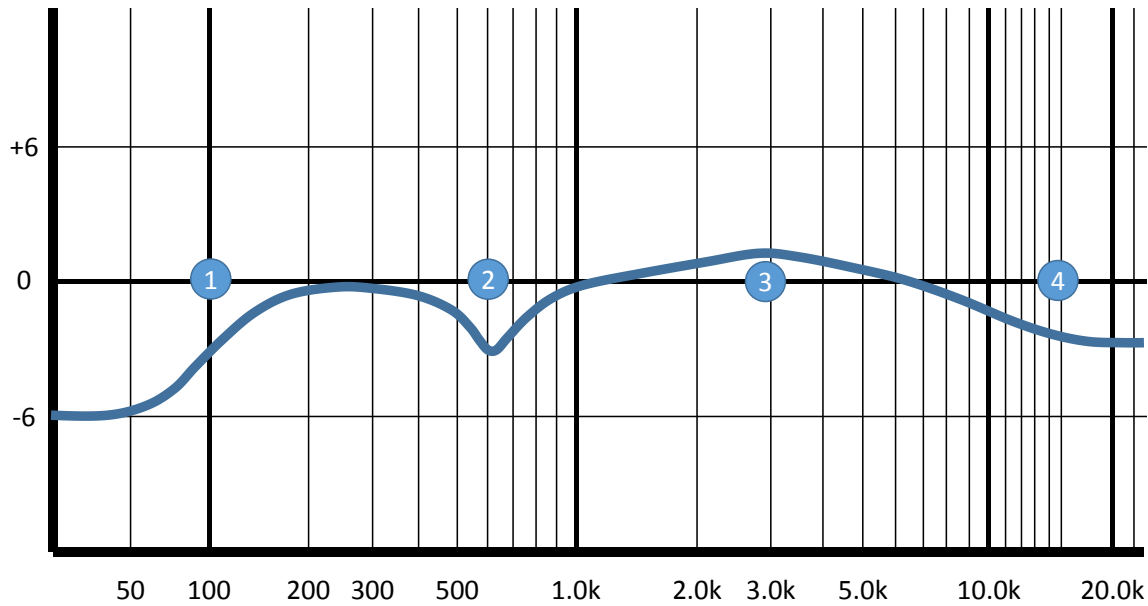

Using the Neuro App, Band 1 (Low Shelf) can optionally be configured as a high pass filter, and Band 2 (High Shelf) can optionally be configured as a low pass filter.

Low Cut Filter

The Lunar also includes a low cut filter (a.k.a. high pass filter) with an adjustable frequency. This filter is very useful for cutting out low frequencies that do not contribute to the sound of the instrument, as well as subsonic frequencies which cannot be heard at all. Bass players often use low cut filters set very low (around 10 Hz to 30 Hz) to reduce speaker excursion and improve the clarity of the bass. Guitarists often use low cut filters set somewhat higher (around 80 Hz) in order to give the bass player additional room in the low end of the mix.

Configurable Low Cut Filter

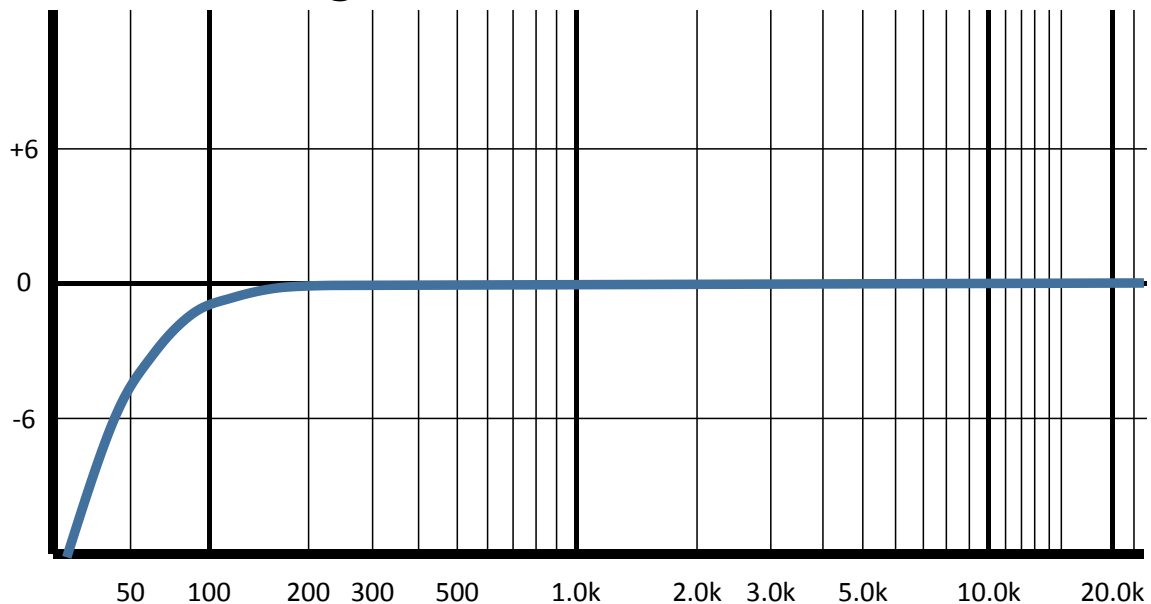

The Parametric EQ and the Low Cut filter are configurable using the Neuro App. By default, the parametric EQ is disabled (flat), and the Low Cut filter is set to 10 Hz.

External Control

The Control Input port opens up a wide array of external control options, allowing for direct control over many of the Lunar's built-in parameters. It can be used as an expression input or as a data port for the Neuro Hub.

Expression Control

The Lunar's effects parameters can be controlled directly by an expression pedal or Hot Hand connected to the Control Input port.

Expression Pedal Input

The Dual Expression Pedal or Reflex Universal Expression Pedal, both from Source Audio, can be directly connected to the Control Input using a 3.5 mm, TRRS cable.

In the case of an expression pedal with a TRRS plug, like Source Audio’s expression pedals, the tip connection is power, the first ring is the X axis expression signal, the second ring is the Y axis expression signal, and the sleeve connection is ground.

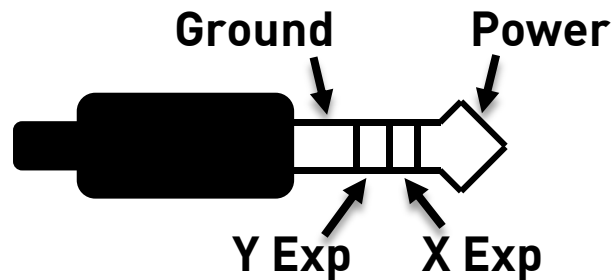

Third party expression pedals can be used as well, as long as they have a TRS (Tip Ring Sleeve) plug with power on the tip, expression (the wiper of the potentiometer) on the ring, and ground on the sleeve, as seen in the diagram below.

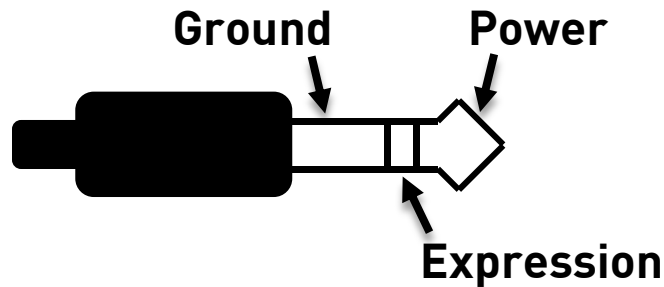

Expression pedals with TS (Tip Sleeve) plugs will not work correctly with the Lunar.

The resistance of the expression pedal does not matter. The Lunar will automatically adjust itself to the range of the expression pedal when it is configured.

Most expression pedals use a ¼” plug, but the Lunar’s control port is 3.5 mm. To make the connection, a simple TRS plug converter (1/4” to 3.5 mm) can be used.

Note that although the Control Port expects a 4-contact TRRS plug, most 3rd party expression pedals use a 3-contact TRS plug. This is OK – using a simple 3-contact TRS plug converter, the expression pedal’s output will be connected to the Lunar’s X expression input.

Configuring the Expression Pedal

It is easier than ever to set up expression control using the Lunar’s new calibration and mapping method. When the expression pedal is connected to the Lunar, follow these simple steps to calibrate it and map it to control different effect parameters.

1. Press the Control Input button to turn on Control Input mode. The Control LED should be lit green.
2. Press and hold the Control Input button until the Control LED begins to blink slowly (approximately one blink per second).

3. Move the expression pedal over the range of motion you would like to use to control the Lunar. If you would like to use the expression pedal's full range of motion, then make sure to move the pedal all the way from its minimum position to its maximum position. Note that you can create "dead zones," if desired, by only moving the expression pedal over a limited region of its full range of motion.
4. After setting the expression pedal range, click the Lunar's footswitch once. The calibration is now complete, and the Control LED will blink faster (about 2 blinks per second). Now, it is time to map the expression pedal to the effect parameters.
5. Move the knob(s) you wish to control with the expression pedal to the minimum desired position, then click the Lunar's footswitch. The Control LED will now blink even faster (about 4 blinks per second). Note that you may control one or more knobs with the expression pedal, up to four total knobs.
6. Move the knob(s) you wish to control with the expression pedal to their maximum desired position, then click the footswitch. The Control LED will now be lit solid green. Note that you may control one or more knobs with the expression pedal, up to four total knobs.
7. After setting the minimum and maximum knob positions, the parameter mapping is complete.

Note: The parameter range can be inverted by swapping the minimum and maximum position of the knobs during calibration.

Hot Hand Input

The Hot Hand 3 Wireless Effects Controller can be connected directly to the Lunar's Control Input for motion control of the Lunar's effects parameters. The Hot Hand has two axes of expression: X and Y. These signals are carried on the two rings of the TRRS cable that comes from the Hot Hand receiver.

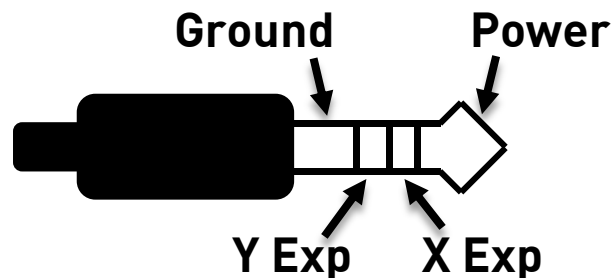

Configuring the Hot Hand

When the Hot Hand is connected to the Lunar, follow these simple steps to calibrate it and map it to control different effect parameters.

1. Press the Control Input button to turn on Control Input mode. The Control LED should be lit green.
2. Press and hold the Control Input button until the Control LED begins to blink slowly (approximately one blink per second).
3. Move the Hot Hand ring over the range of motion you would like to use to control the Lunar. The easiest way to do this is to move the ring in the same way that you intend to move it as

you perform. The Lunar will intelligently select the X or Y axis of the Hot Hand automatically, based on the motion of the ring.

4. After setting Hot Hand range of motion, click the Lunar's footswitch once. The calibration is now complete, and the Control LED will blink faster (about 2 blinks per second). Now, it is time to map the Hot Hand to the effect parameters.
5. Move the knob(s) you wish to control with the Hot Hand to their minimum desired position, then click the Lunar's footswitch. The Control LED will now blink even faster (about 4 blinks per second). Note that you may control one or more knobs with the Hot Hand, up to four total knobs.
6. Move the knob(s) you wish to control with the Hot Hand to their maximum desired position, then click the Lunar's footswitch. The Control LED will now be lit solid green. Note that you may control one or more knobs with the Hot Hand, up to four total knobs.
7. After setting the minimum and maximum knob positions, the parameter mapping is complete.

Note: The parameter range can be inverted by swapping the minimum and maximum position of the knobs during calibration.

Reset Expression Control Mapping

To clear the expression control mapping (Expression or Hot Hand), first press the Control Input button and turn off Control Input mode. The Control LED should be dark. Then, press and hold the Control Input button until the Control LED blinks. This clears all Expression, Hot Hand, and MIDI mapping.

Neuro App

The Neuro App is available as a free download for iOS and Android devices. Get the iOS version from the App Store or the Android version from the Play Store. The Neuro App provides access to a number of parameters that are not accessible on the control knobs, as well additional effect types. In order to use the Neuro App, use the included 3.5 mm to ¼" TRS cable to make a connection between the headphone jack on your mobile device and the Input 2 jack on the hardware. The Neuro App uses special audio signals sent over your mobile device's headphone jack to remotely control the pedal. Make sure the headphone volume on your mobile device is set to maximum when using the Neuro App for the most reliable device to pedal communication.



Main Menu

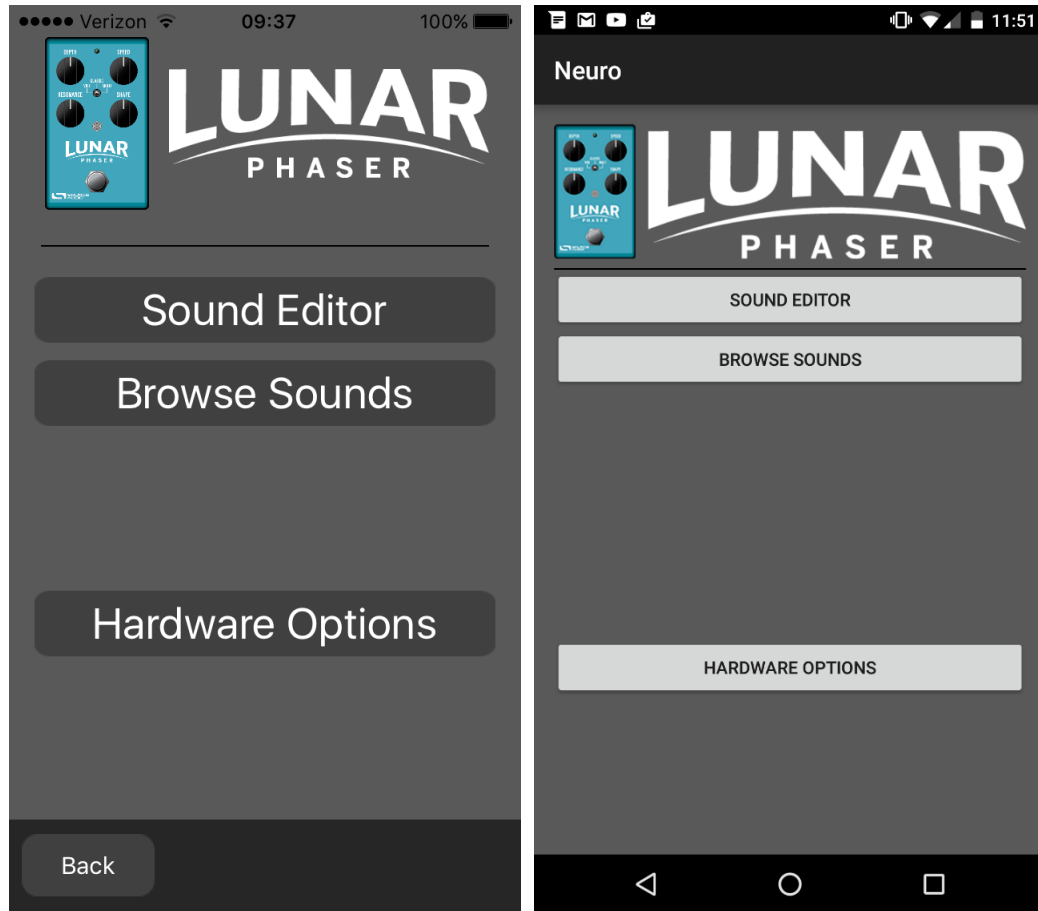

The main menu includes links to the three main sections of the app:

- Sound Editor allows the user to edit the current effect or create a new sound from scratch. These sounds can be burned into the internal preset memory (three sounds corresponding to the three positions of the effect selector switch, and an additional preset accessible via the footswitch), saved to a preset file in the app, emailed to friends, posted to the Neuro Community site, and more.
- Browse Sounds opens a library of sounds to choose from, divided into User, Factory, Published, and Web categories. This is a place to organize and share your favorite settings. You can also explore sounds and settings made by other users.
- Hardware Options allows access to the global options for the hardware. Global options are “set and forget” type settings that are NOT saved per preset.

Sound Editor

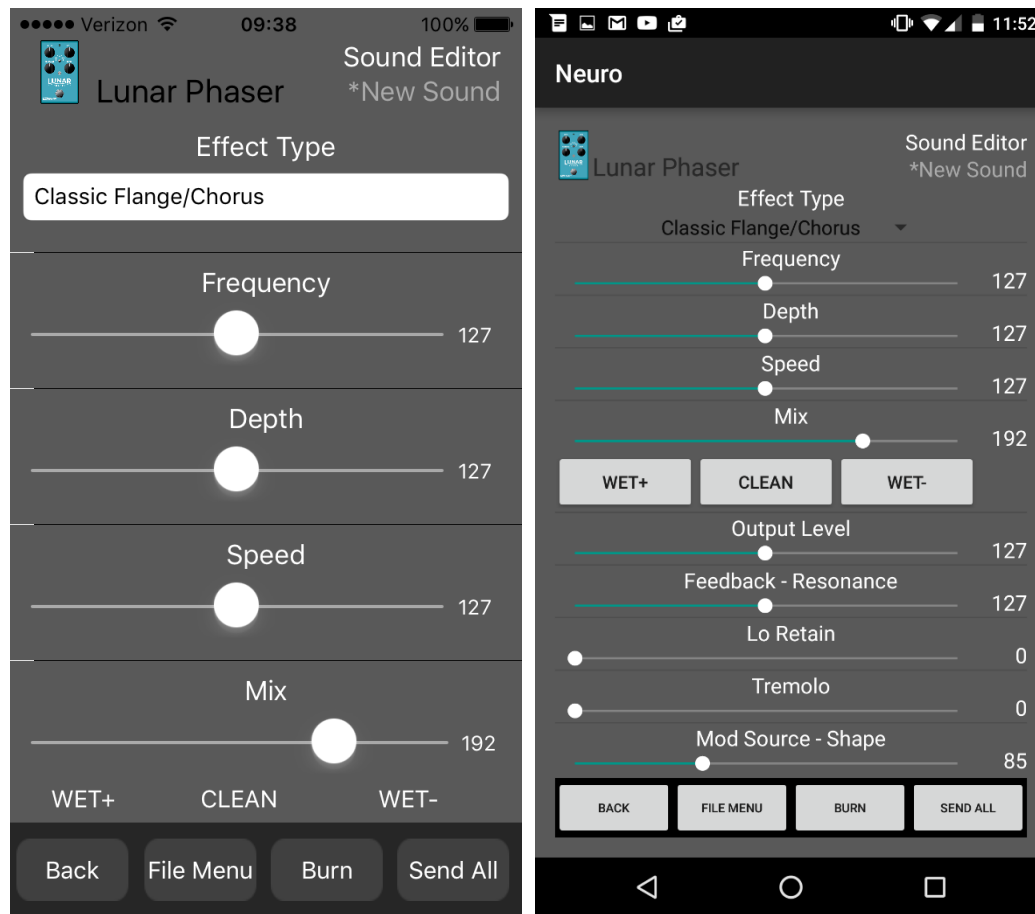

The Sound Editor displays a wide range of parameters that can be changed to create different sounds. The Sound Editor works kind of like a remote control for a TV – only the parameters you touch on the screen will be modified on the hardware; all other parameters remain unchanged.

The links at the bottom of the screen allow access to the File Menu, the Burn command, and the Send All command.

Send All

If you wish to update all of the parameters on the hardware so that they match what is shown on the Sound Editor screen, tap the Send All button. This sends every parameter setting over to the hardware and guarantees that its settings will exactly match what is shown in the app.

File Menu

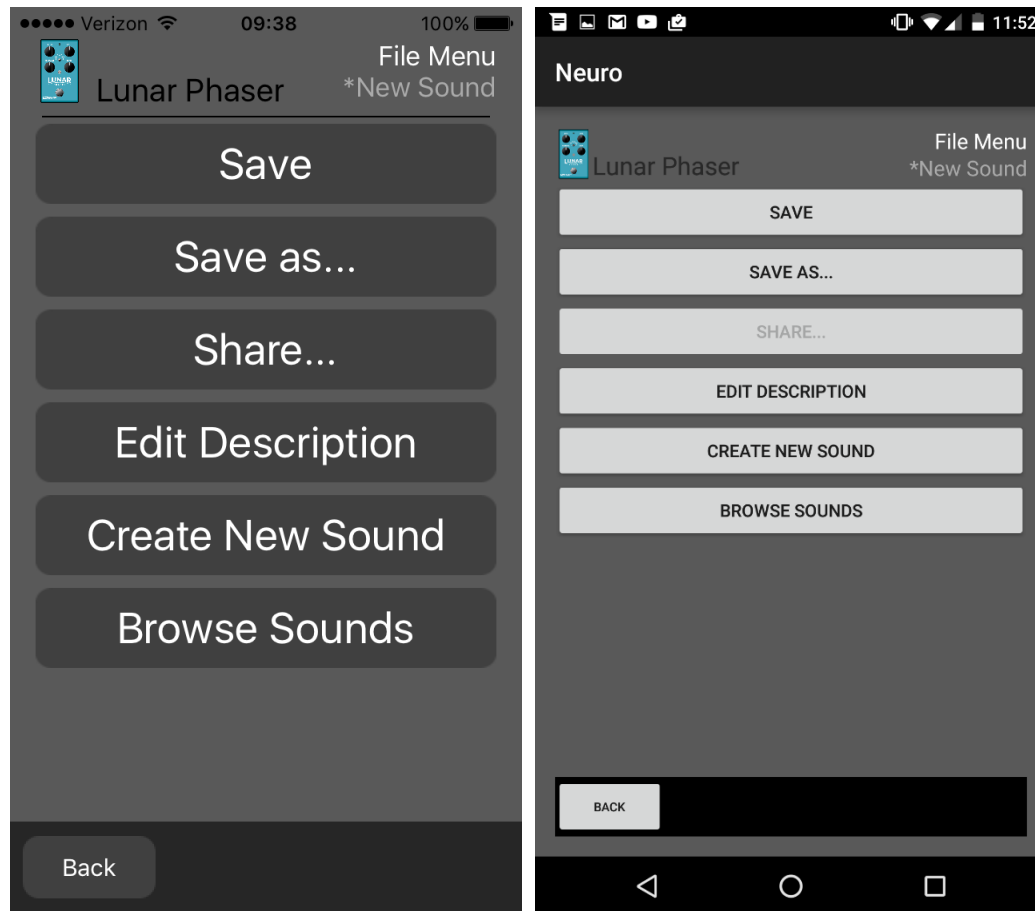

The File Menu displays different options for the sound you're currently editing in the Sound Editor.

Save

Saves the current settings from the Sound Editor. If you haven't saved yet, this will perform a Save As.

Save As

Allows you to save the current settings to a new file. You can choose a file name and description.

Share

Allows you to send the current settings to a friend as a text message or email attachment.

Edit Description

Edits the description that accompanies the preset in the Browse Sounds menu.

Create New Sound

Closes the current sound being edited and opens a new sound for editing with default settings.

Browse Sounds

Returns to the Browse Sounds screen, which displays a list of user and web presets.

Burn

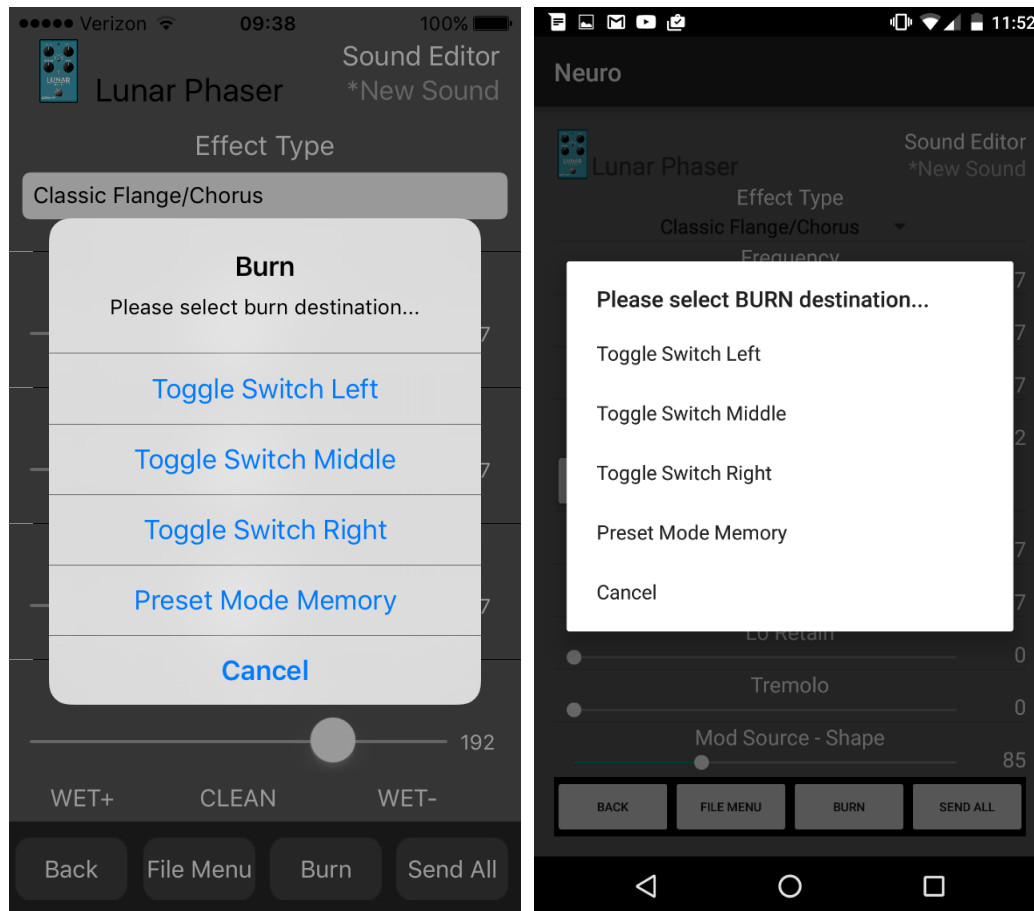

The Burn command takes the current sound that is running in the hardware and “burns” it to the internal memory for later use. Burn works as a “what you hear is what you get” type of control; it will save all of the settings in their current state, as you hear them, and put those into memory. This will not necessarily match the exact settings shown in the Sound Editor for all parameters **unless** you have performed a [Send All](#) command first.

After selecting the Burn command, a list of target locations in memory is displayed. There are a total of 4 options: the 3 factory slots that correspond to the effect selector switch, and the 1 slot in preset memory.

Replacing an Effect on the Effect Switch

It is possible to replace one of the main effect types with one of the extended effect types or with a user-created sound. To do this, follow these steps:

- Load the sound in the Sound Editor.
- Hit the Send All button.
- Hit the Burn button.
- Select one of the Effect Selector Switch positions to overwrite it.

Browse Sounds

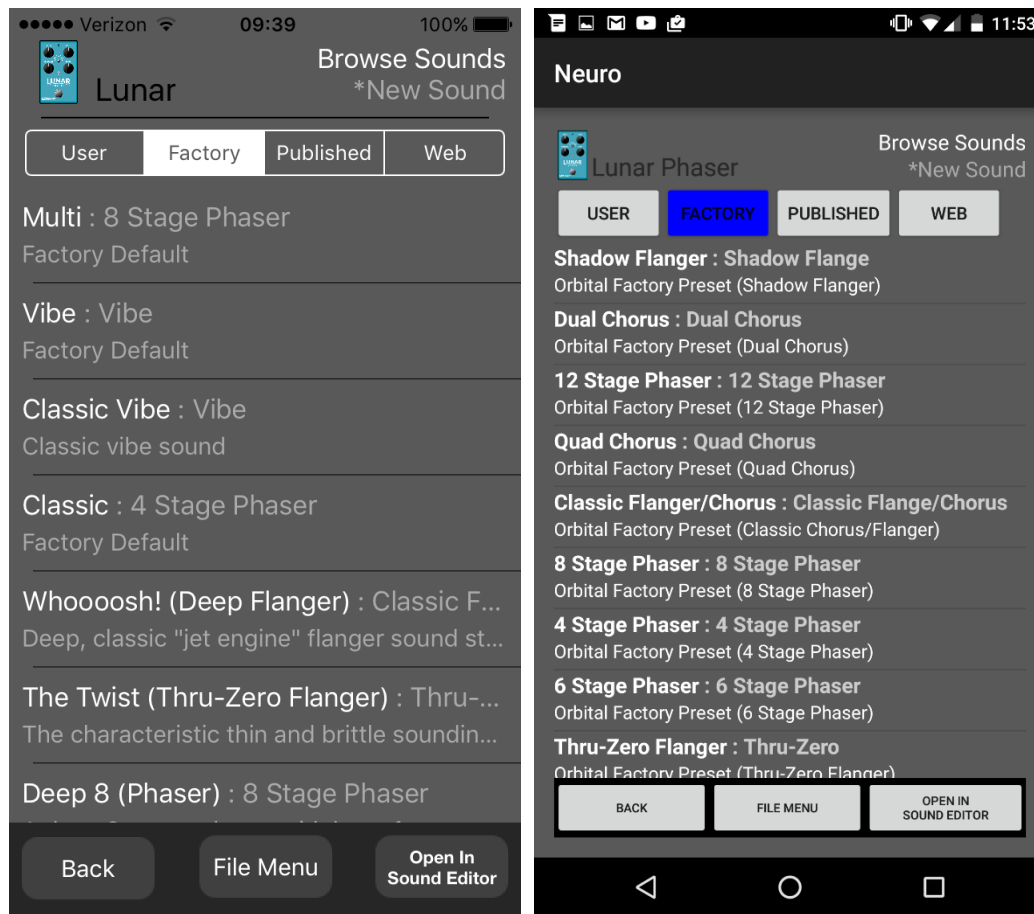

The Browse Sounds screen displays lists of presets that can be easily loaded into the hardware. Just tap on a preset name to send it to the hardware, and you should be able to hear it instantly.

Presets are divided into four sections:

- **User:** Presets that you have created and saved.
- **Factory:** Presets that were created by Source Audio. New presets will automatically be added to this list as Source Audio creates them.
- **Published:** Presets that you have created and uploaded to the Neuro Community for other users.
- **Web:** Presets created and shared by other users.

Open In Sound Editor

The Open In Sound Editor button allows you to take the currently selected preset and open it in the Sound Editor for editing and customization.

Deleting or Publishing Presets

Swipe to the left on any preset name for additional options. Tap DELETE to remove the preset from your device. Tap PUBLISH to publish the preset – this lets other Neuro users enjoy your creation!

Hardware Options

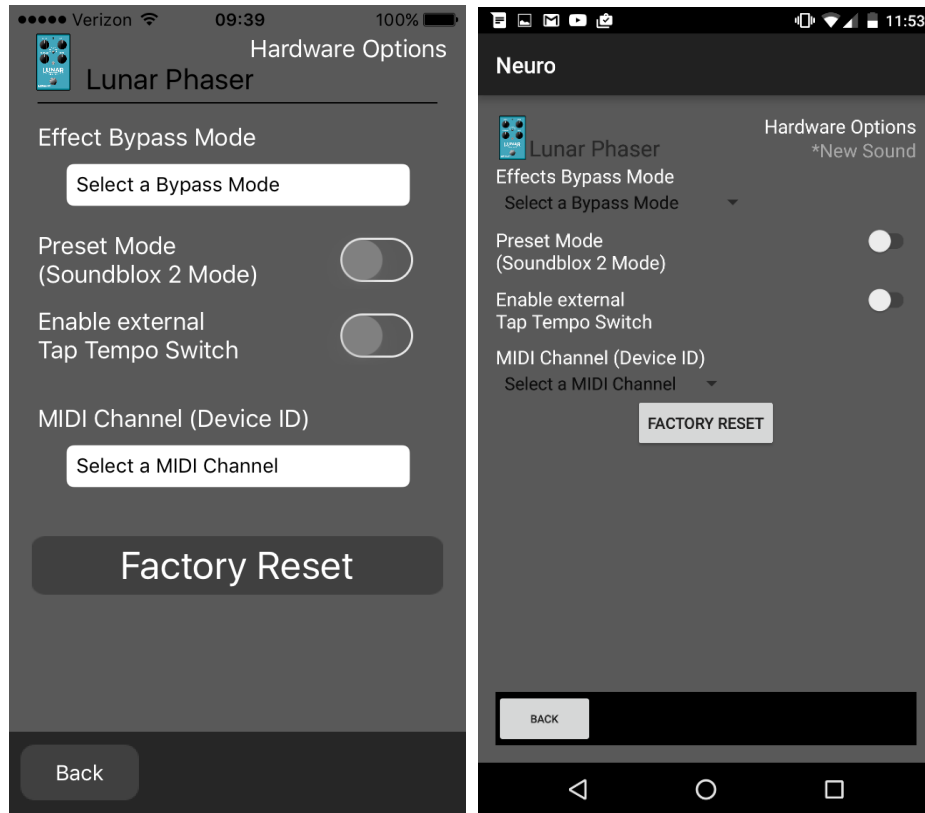

This screen shows some advanced options.

Effect Bypass Mode

Selects which bypass path will be used for presets that use hardware bypass mode.

- True Bypass (Relay) uses two relays for true bypass switching.
- Active Analog (Buffered) bypass uses a buffer to help prevent signal loss and clicking.

MIDI Channel (Device ID)

Selects which channel (1 to 16) the hardware will respond to on Hub and USB-MIDI inputs.

Preset Mode (Soundblox 2 Mode)

Enables the preset saved in memory to be loaded each time the effect is enabled using the footswitch. This loads all settings from the preset and ignores the knob positions. When Preset Mode is enabled, the main LED will be red instead of green. Preset Mode can also be enabled/disabled by pressing and holding the footswitch for a few seconds.

Enable External Tap Tempo Switch

Allows the Source Audio tap tempo switch to be connected to the Control Input Port. This allows the tempo for the LFO to be tapped in directly. The Control LED will blink in time with the tempo if this mode is enabled.

Factory Reset

Resets the internal memory (including all presets and effect types) to the factory default settings.

Quick Preset Mode

Allows preset mode to be enabled/disabled in 0.8 seconds instead of 5 seconds (by holding down the footswitch).

Neuro Hub (Formerly the Soundblox Hub)

The Source Audio Neuro Hub (sold separately), unites Source Audio pedals from the Soundblox 2 and One Series families to create a single, stage-ready system. It features shared MIDI, passive expression pedal input, Hot Hand connectivity, and USB, and can connect to up to five Source Audio pedals. The Neuro Hub features a powerful scene saving functionality, which allows you to create up to 128 multi-pedal presets known as scenes, each recallable via MIDI program change messages. Connect the Neuro Hub to your computer via USB for updates, saving and editing multi-pedal presets, and more. To connect the Lunar to the Neuro hub, use a 3.5 mm TRRS cable and make a connection between the Lunar's Control Input jack and any of the Neuro Hub's multi-function outputs. For more information, refer to the Neuro Hub documentation on the Source Audio website.

MIDI

Using a USB connection or the Neuro Hub (sold separately), the Lunar can be controlled by generic MIDI messages. Each of the Lunar's parameters (even those that are not assigned to a control knob) is directly accessible via MIDI continuous controller messages. MIDI messages can be sent directly via USB or forwarded on to the Lunar via the Neuro Hub.

MIDI Learn

MIDI Continuous Control messages

In order to assign a MIDI continuous controller to one of the four knobs, the effect selector switch, or the enable/bypass footswitch, follow these steps:

1. Press the Control Input button to turn on Control Input mode. The Control LED should be lit green.
2. Press and hold the Control Input button until the Control LED begins to blink slowly (approximately one blink per second).
3. Send a MIDI continuous control message to the Lunar via USB or the Neuro Hub. When a valid continuous control message is received, the Control LED will begin to blink faster (about two blinks per second).
4. To assign this continuous controller to a knob, turn the corresponding knob. To assign it to the enable/bypass footswitch, press the footswitch. To assign it to the effect type switch, toggle the effect type switch.
5. Once the MIDI continuous controller has been assigned, the Control LED will be solid green. This shows that the mapping was successful. **Note:** The Control LED blinks any time a MIDI message is received, so it's possible that the Control LED will continue blinking even after the MIDI mapping is complete – this shows that MIDI messages are still being sent to the Lunar.

For parameters like depth and speed, which are normally controlled by knobs, the full range of continuous control values from 0 to 127 will be mapped to the range of the knob.

For the enable/disable footswitch, continuous control values in the range from 0 to 63 will bypass the Lunar and values in the range from 64 to 127 will enable the Lunar.

For the effect type switch, continuous control values map directly to each effect type. 7 = Vibe, 8 = Classic (4-Stage), and 10 = Multi (8-Stage). Other values map to additional effect types that are available in the Neuro App.

Any MIDI CC, from 0 to 127, can be mapped to a control on the Lunar.

Each CC number can only be mapped to control one parameter at any given time. If you attempt to map a CC that has already been assigned to another parameter, the previous mapping will be overridden.

Several CCs can potentially be mapped to the same parameter, although this is not very useful.

When using MIDI Learn, the Lunar listens for the first MIDI CC message sent to it and then ignores any subsequent CC messages until the mapping is complete. This means that you must make sure that only send the MIDI CC message to the Lunar that you intend to use for the MIDI Learn mapping. Some DAWs send multiple MIDI messages when the play or pause buttons are pressed, and this can lead to unintended MIDI mappings. Check your DAW documentation in order to learn about messages that are sent at the beginning or end of playback.

Reset MIDI Mapping

To clear MIDI mapping, first press the Control Input button and turn off Control Input mode. The Control LED should be dark. Then, press and hold the Control Input button until the Control LED blinks. This clears all Expression, Hot Hand, and MIDI mapping.

MIDI Channel

By default, the Lunar responds to MIDI Channel 1. The Lunar ignores all MIDI messages sent to it that are not on its assigned channel, with the exception of MIDI clock messages. To change the Lunar's MIDI channel, edit the Lunar's global settings using the Neuro App.

MIDI Clock

The Lunar syncs to MIDI clock (also known as MIDI timing clock or MIDI beat clock). MIDI clock is tempo-dependent and is used to ensure that multiple MIDI-enabled devices stay in synchronization. A common use of MIDI clock with the Lunar is when recording along to a click track in a DAW (Digital Audio Workstation) running on a computer. MIDI clock can be sent to the Lunar directly over USB-MIDI or via the Control Port from the Neuro Hub.

The Lunar begins to sync its LFO to the MIDI Clock as soon as the first MIDI Clock message is received. If the tempo changes, the rate of MIDI Clock messages will change as well, and the Lunar will adjust to resynchronize itself accordingly. The Lunar doesn't require any special configuration to use MIDI Clock; just start sending it MIDI Clock messages and it will synchronize itself automatically.

By default, the LFO starts synchronized with the first MIDI Clock message received. If you wish to offset the LFO start time, for example by an eighth note, simply start playback in your DAW an eighth note earlier or later than the beginning of the measure.

After the Lunar receives its first MIDI clock message, the function of the Speed Knob changes. Instead of controlling the speed of the LFO directly, it controls the number of subdivisions are in the LFO, using the MIDI clock as a basis for the tempo. One, two, three, or four subdivisions can be created. Musically speaking, this means that the LFO can run at the rate of quarter notes, eighth notes, triplets, or sixteenth notes. The following diagram shows the knob positions corresponding to each subdivision, with the knob currently set to quarter notes:

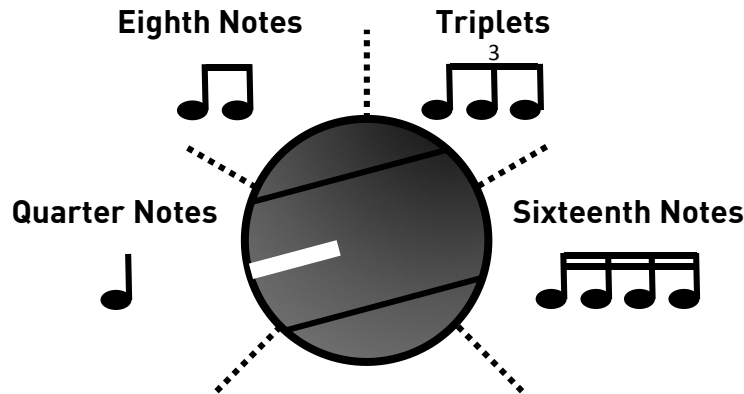

The number of subdivisions can also be modified via MIDI using the Speed parameter. If you have mapped a MIDI CC message to the Speed parameter, you can choose the number of subdivisions using the following table:

| MIDI CC Speed Value | LFO Subdivisions | Musical Equivalent |
|---------------------|------------------|--------------------|
| 0 to 31 | 1 | Quarter Note |
| 32 to 63 | 2 | Eighth Note |
| 64 to 95 | 3 | Triplet |
| 96 to 127 | 4 | Sixteenth Note |

The Lunar does not sync to MIDI timecode containing SMPTE timestamps.

USB

The Lunar’s USB port is plug-and-play ready for Windows and Mac computers. The Lunar uses class-compliant drivers, so no special drivers are needed. Just power up the Lunar and connect it to the computer using a USB cable. The computer should automatically recognize the Lunar, which will be identified as “Source Audio One Series” in the operating system.

USB-MIDI

The Lunar will appear as a MIDI device in your computer’s operating system. As a result, the Lunar can communicate with audio production software that utilizes MIDI, such as Pro Tools, Ableton Live, Logic Pro, and more. MIDI messages can be sent directly to the Lunar using the USB connection, which allows for full automation of the Lunar within host software such as a DAW. For example, the depth or speed of the LFO can be automated by outputting MIDI continuous controller messages from the host software to the Lunar via the USB connection.

External Tap Tempo

The Lunar supports an external tap tempo switch that can be connected to its Control Input port. Tap tempo can be used to directly input a tempo and override the speed knob. Tap tempo is disabled by default; it can be enabled in the hardware options menu in the Neuro App.

When External Tap Tempo mode is active, the Speed knob acts to set the beat subdivisions, just as it does when [MIDI Clock](#) is enabled.

Source Audio makes tap tempo switches that are compatible with the Lunar. These switches can be purchased on the store on Source Audio’s website.

The plug going to the tap tempo footswitch must be TRRS and have the signal connections as shown in the following figure.

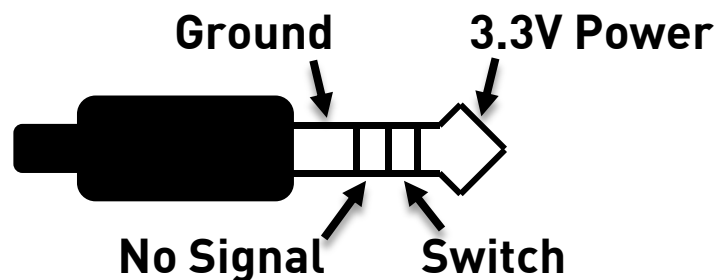

The tap tempo switch needs to be more than a simple switch; a pull-up resistor and RC passive low pass filter are required. The circuit for the footswitch is shown in the following figure:

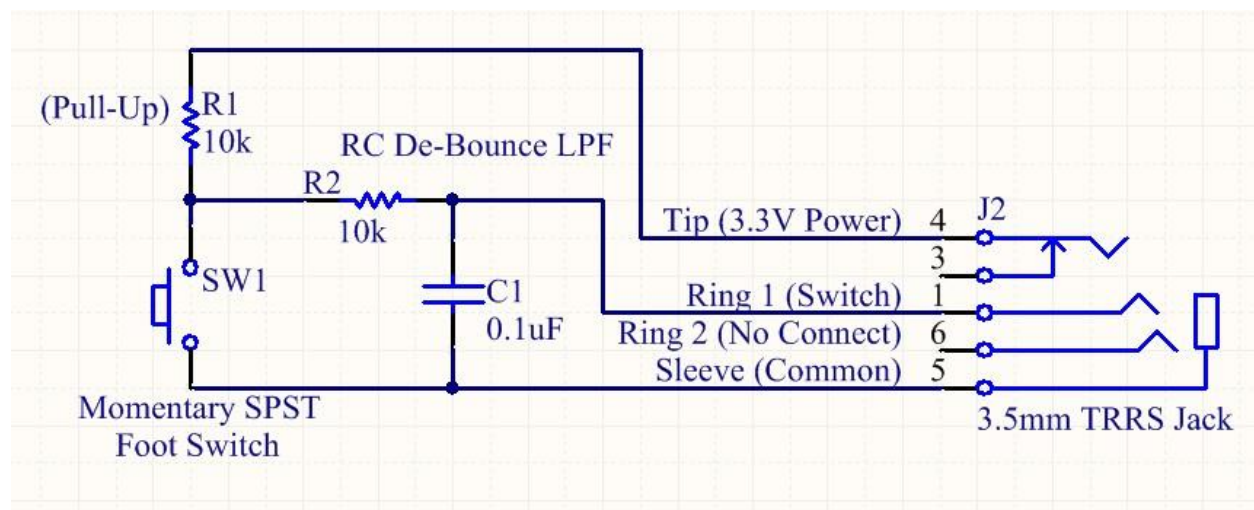

Specifications

Dimensions

- Length: 11.63 cm (4.58 inches)
- Width: 7.00 cm (2.75 inches)
- Height (not including knobs and footswitch): 3.71 cm (1.46 inches)

- Height (including knobs and footswitch): 5.61 cm (2.21 inches)

Weight

- 280 grams (0.625 pounds)

Power

- 180 mA @ 9V DC (max 220 mA with Hot Hand Wireless Adapter)
- Negative tip (positive sleeve) barrel power jack, 2.1 mm inner diameter, 5.5 mm outer diameter

Audio Performance

- Maximum Input Level: +6 dBV = 8.2 dBu = 2 V RMS = 5.6 V p-p
- Input Impedance: 1 MegaOhm (1 M Ω)
- Output Impedance: 600 Ohm (600 Ω)
- 108 dB DNR Audio Path
- 24-bit Audio Conversion
- 56-bit Digital Data Path
- Universal Bypass™ (relay-based true bypass and analog buffered bypass)

Troubleshooting

General

Restore factory settings: In order to revert the Lunar to its factory settings, clearing all user data, presets, expression mappings and custom effect types, perform a factory reset using one of the methods described below.

Factory Reset using the Neuro App

Using the Neuro App, go to Hardware Settings and choose the Factory Reset option.

Factory Reset using the Hardware (Firmware v1.06 and later)

Disconnect power. While holding down the footswitch, reconnect power. The main LED and control LED will be lit for a few seconds. When the reset is complete both LEDs will turn off and you can release the footswitch.

Noise

Power source: Ensure that the proper power supply is being used.

Near noise source: Move pedal away from power supplies and other equipment.

Other equipment: Remove other effects from signal chain; see if noise persists.

Bad cables: Swap out audio cables.

USB ground loop: When connected to a computer using a USB cable, noise can appear in the audio signal. This usually results from ground loop noise due to the Lunar and computer running on separate power supplies. In the case of laptops, the noise can often be mitigated by disconnecting the computer's power supply and running it on a battery. External display monitors are often the primary source of noise, and powering down monitors can also resolve noise issues.

Hot Hand Doesn't Work

Low power: Ensure that the proper power supply is being used.

Not calibrated properly: Calibrate the Hot Hand. See the [Hot Hand Input](#) section for more details.

Not connected properly: Check Hot Hand connections.

Unit Appears Dead / No LEDs Lit

Wrong power supply: Use correct power supply. See the [DC 9V \(Power\)](#) section for more details.

Corroded power cable plug: Check power plug for corrosion on sleeve. Swap out power supply if necessary.

Frequently Asked Questions

How do I change the routing mode for my pedal without changing anything about the sounds?

- Connect the Neuro App cable and go to the Sound Editor in the app.
- Flip the toggle switch on the hardware to the left position.
- In the app, go to the I/O Routing Option (bottom of the list), select it, and the desired routing mode. Then tap Done. You should see the Control LED blink when the message is received.
- Tap the Burn button. This opens a menu for burning locations.
- Select "Toggle Switch Left". This burns any changes you made into memory. Since you only changed the I/O Routing mode, that will be the only thing that is changed. The rest of the parameters for that sound will remain unchanged.
- Repeat these steps for the middle switch position and the right switch position.

What kind of instruments can I connect to the Lunar's inputs?

The Lunar's audio inputs are high impedance ($\sim 1\text{ M}\Omega$) and they can accept high impedance signal sources like guitars/basses with passive pickups, as well as low impedance sources like line-level audio circuits, guitars/basses with active pickups, electronic keyboards, or mixer outputs. The input circuit can handle signals ranging up to 5.6 Volts, peak-to-peak.

Can I power the Lunar directly over USB, without using the 9 Volt supply?

No. USB provides 5 Volts, but the Lunar needs 9 Volts, so the Lunar cannot be powered directly from USB. Make sure that you have plugged in the included 9V DC power supply when connecting to the Lunar's USB port.

When connecting the Lunar to a recording interface or mixer, should I use a Lo-Z (microphone) or Hi-Z (line / instrument) input?

The Lunar's output will be low impedance when the effect is active or in buffered bypass mode, but it will be high impedance when using true bypass mode and a guitar with passive pickups. Therefore, it is recommended that you use a high impedance (Hi-Z) input on your recording interface or mixer to avoid signal loss.

Why doesn't the Lunar respond to MIDI messages being sent to it?

By default, the Lunar should respond to MIDI continuous controller messages on channel 1 (in technical terms, this means that the lower 4 bits in the command byte of MIDI messages should be 0000 in binary or 0 in hexadecimal). The Lunar's MIDI channel can be configured using the Neuro App. Channel numbers in MIDI use zero-based counting, so MIDI channel 1 is described as 0 in hexadecimal, MIDI channel 2 is described as 1 in hexadecimal, and so on, concluding with MIDI channel 16, which is described as F in hexadecimal. A continuous controller message starts with a hexadecimal B and is followed by the channel number (0 through F). So, the command byte from your MIDI controller should be formatted as shown in the following table:

| MIDI Channel (Decimal) | 1 | 2 | 3 | 4 | 5 | 6 | 7 | 8 | 9 | 10 | 11 | 12 | 13 | 14 | 15 | 16 |
|------------------------|----|----|----|----|----|----|----|----|----|----|----|----|----|----|----|----|
| CC Command Byte (Hex) | B0 | B1 | B2 | B3 | B4 | B5 | B6 | B7 | B8 | B9 | BA | BB | BC | BD | BE | BF |

Each continuous controller command byte is followed by two bytes, the CC number and the value. So, each CC message consists of a total of three bytes. If the Lunar is not responding to MIDI, make sure that your MIDI controller is properly configured and sending messages in the format described above.

How do I enable extended effect types via MIDI?

Refer to the [MIDI Learn](#) section to map a MIDI continuous controller to the Effect Type switch. Then, send a CC message with one of the following values to enable a certain effect type:

| CC Value | Effect Type |
|----------|-----------------------|
| 0 | Classic Flange/Chorus |
| 1 | Shadow |
| 2 | Thru-Zero |
| 3 | Resonator 1 |
| 4 | Resonator 2 |
| 5 | Dual Chorus |
| 6 | Quad Chorus |
| 7 | Vibe |
| 8 | 4 Stage Phaser |
| 9 | 6 Stage Phaser |
| 10 | 8 Stage Phaser |
| 11 | 12 Stage Phaser |

Additional effect types may become available in future updates.

Can I use the Lunar in my amp’s effects loop?

The audio inputs can handle up to 8.2 dBu or 5.6 Volts peak-to-peak, which allows them to work in most amp effects loops. In order to avoid clipping, be sure to check your amp’s documentation and verify that the maximum send level is less than 5.6 Volts peak-to-peak.

Rubber Feet

The Lunar comes standard with a flat aluminum bottom, making it easy to apply Velcro and mount to a pedalboard. Additionally, adhesive rubber feet are included in the Lunar’s box. Applying the rubber feet to the Lunar can help prevent it from sliding on flat surfaces such as a hardwood floor.

Waste Disposal Notes



If possible, dispose of the device at an electronics recycling center. Do not dispose of the device with the household waste.

For full compliance with EN 61000-4-6 standard, input cable must be less than 3 meters in length.

Warranty

Limited Transferrable Warranty

Source Audio, LLC (hereinafter “Source Audio”) warrants that your new Source Audio One Series Lunar Phaser, when purchased at an authorized Source Audio dealer in the United States of America (“USA”), shall be free from defects in materials and workmanship under normal use for a period of two (2) years from the date of purchase by the original purchaser. Please contact your dealer for information on warranty and service outside of the USA.

Under this Limited Warranty, Source Audio’s sole obligation and the purchaser’s sole remedy shall be repair, replacement, or upgrade, at Source Audio’s sole discretion, of any product that, if properly used and maintained, proves to be defective upon inspection by Source Audio. Source Audio reserves the right to update any unit returned for repair and to change or improve the design of the product at any time without notice. Source Audio reserves the right to use reconditioned parts and assemblies as warranty replacements for authorized repairs. Any product repaired, replaced, or upgraded pursuant to this Limited Warranty will be warranted for the remainder of the original warranty period.

This Limited Warranty is extended to the original retail purchaser. This Limited Warranty can be transferred to anyone who may subsequently purchase this product provided that such transfer is made within the applicable warranty period and Source Audio is provided with all of the following information: (i) all warranty registration information (as set forth on the registration card) for the new owner, (ii) proof of the transfer, within thirty (30) days of the transfer, and (iii) a photocopy of the original sales receipt. Warranty coverage shall be determined by Source Audio in its sole discretion. This is your sole warranty. Source Audio does not authorize and third party, including any dealer or sales representatives, to assume any liability on behalf of Source Audio or to make any warranty on behalf of Source Audio.

Warranty Information

Source Audio may, at its option, require proof of the original purchase date in the form of a dated copy of the original authorized dealer’s invoice or sales receipt. Service and repairs of Source Audio products are to be performed only at the Source Audio factory or a Source Audio authorized service center. Prior to service or repair under this Limited Warranty, the purchaser must request from Source Audio a return authorization, which is available at:

Source Audio LLC
120 Cummings Park, Woburn, MA 01801
(781) 932-8080 or at www.sourceaudio.net

Unauthorized service, repair, or modification will void this Limited Warranty.

Disclaimer and Limitation of Warranty

Do not open the effects pedal under any circumstance. This will void the warranty.

The foregoing limited warranty is the only warranty given by Source Audio and is in lieu of all other warranties. All implied warranties, including warranties of merchantability and fitness for any particular purpose, exceeding the specific provisions of this limited warranty, are hereby disclaimed and excluded from this limited warranty. Upon expiration of the applicable express warranty period, Source Audio shall have no further warranty obligation of any kind, express or implied. Source Audio shall in no event be liable for any special, incidental, or consequential damages suffered by the purchaser or any third party, including without limitation, damages for loss of profits or business or damages resulting from use or performance of the product, whether in contract or in tort. Source Audio shall not be liable for any expenses, claims, or suits arising out of or relating to any of the foregoing. Some states do not allow the exclusion or limitation of implied warranties so some of the above limitations and exclusions may not apply to you. This Limited Warranty gives you specific legal rights, and you may also have other rights, which vary, from state to state. This Limited Warranty only applies to products sold and used in the USA. Source Audio shall not be liable for damages or loss resulting from the negligent or intentional acts of the shipper or its contracted affiliates. You should contact the shipper for proper claims procedures in the event of damage or loss resulting from shipment.

Version History

July 9, 2015: Initial Release

July 22, 2015: Updated [Saving Your First Preset](#) section

August 24, 2015: Added [External Tap Tempo](#) section

January 4, 2016: Added [Neuro App](#) section

February 4, 2016: Added new information for firmware version 1.06 ([Hardware factory reset](#), [automatic stereo routing](#), [quick preset mode](#)). Added [amp effects loop](#) to FAQ.

February 19, 2016: Added Android support.



©Source Audio LLC | 120 Cummings Park, Woburn, MA 01801 | www.sourceaudio.net